

DEWALT®



ANCHORS & FASTENING SYSTEMS

www.DEWALT.com

GUARANTEED TOUGH.®

DEWALT®

ANCHORING & FASTENING EXPERTISE

DEWALT is a recognised global leader in designing and manufacturing solutions for the construction industry with extensive expertise in mechanical and adhesive anchors, light-duty fastening and direct fastening systems.

TESTED TO EXTREMES

The products in this catalogue have been through the most rigorous development and testing programmes and provide innovative solutions with the reassurance of high performance and full compliance with relevant building codes backed by comprehensive technical documentation and design software.

As a result, you can be sure of each and every fastener.

DEWALT Anchors and Fastening Systems - the first name for construction fastening.





WHY DEWALT?

END USER RESEARCH

On average, we speak to 20,000 users every year as part of the product development process.

A comprehensive understanding of the real applications that our users perform enables us to generate product features that are a genuine benefit to our users.

INNOVATIVE PRODUCTS

To support our users and drive our industry forward, **DEWALT** consistently develops truly innovative products, across multiple categories.

This technical strength is regularly recognised by international design awards.

THE COMPLETE RANGE

DEWALT supplies a full range of anchors and fastening systems as well as power tools and accessories giving the building contractor and professional tradesman the complete system for construction fixing.

USER LOYALTY

The cast-iron **DEWALT** guarantee and premium service network ensures that our users have faith in the quality of our products. First-time buyers will become loyal **DEWALT** users.

DEWALT is heavily involved in end user events across Europe - building our brand reputation, and generating huge excitement around our diverse product portfolio.

THE COMPLETE SOLUTION FROM START TO FINISH

ANCHORS

Versatility with advanced fixing technology built in, the DEWALT anchors and fasteners range are engineered to offer fastening solutions in the most demanding conditions.

A new addition to DEWALT range, the new mechanical anchors, fixings, adhesive anchors and direct fastening systems offer the complete solution; whether completing a simple DIY task or specifying anchors on a major engineering project.

KEY ATTRIBUTES TO THIS NEW RANGE INCLUDE:

- Full compliance with industry specification and ETA / CE certification applying to a large number of products in the range.
- Core product range for use in many applications from DIY and Trade contractors to construction and engineering projects.
- Comprehensive UK technical support and advice available.
- Range planning, merchandising and marketing support available including an extensive technical and image library.

TESTED TO EXTREMES



DIRECT FASTENING

MECHANICAL ANCHORS

ADHESIVE ANCHORS



ACCESSORIES

XLR BITS FOR SDS-PLUS® & SDS MAX® HAMMERS

- Solid carbide tip with 4 cutters giving long life and durability
- 4 cutter heads drill a more concentric hole for improved fixing retention
- 4 flute spirals aid consistent drilling speed and efficient debris removal

EXTREME MASONRY DRILL BITS

- Innovative Tip Design - unique design provides an efficient drilling action and reduced walking for greater accuracy
- Up to 50% more holes per charge when used with cordless drills



TOOLS

DEWALT is constantly pushing the boundaries to create innovative tools for the construction professional.

Tools carrying the Perform & Protect shield are designed to exceed the highest demands of the job site whilst meeting strict criteria in key health and safety issues:

- **CONTROL** – unique and innovative torque features help to protect the end user from accidental jams.
- **VIBRATION** - integrated vibration dampening systems allow users to operate tools safer for longer.
- **DUST** – advanced dust control guards against dust inhalation, helping to create a cleaner, safer working environment.



18V & 36V
CORDLESS
SDS HAMMERS



45MM SDS-MAX
COMBINATION
HAMMER



26MM HEAVY DUTY
SDS-PLUS COMBINATION
HAMMER



26MM L-SHAPE
SDS-PLUS COMBINATION
HAMMER



SPECIALLY SELECTED FOR ANCHOR INSTALLATION



**18V XR LI-ION HEAVY DUTY
3 MODE QUICK CHANGE CHUCK
DEDICATED CORDLESS HAMMER**

DCH254M2

Battery Capacity 4.0 Ah
Power Output 400 Watt
Blows per Minute 0-4500 bpm



No Load Speed	0 - 1200 rpm
Impact energy (EPTA 05/2009)	2.1 J
Tool Holder	SDS-Plus
Max. Drilling Capacity [Wood]	26 mm
Max. Drilling Capacity [Metal]	13 mm
Max. Drilling Capacity [Concrete]	24 mm
Weight	3.2 kg
Hand/Arm Vibration - Drilling	6.6 m/s ²



**36V LI-ION HEAVY DUTY
3 MODE QUICK CHANGE CHUCK
DEDICATED CORDLESS HAMMER**

DCH364M2

Battery Capacity 4.0 Ah
Power Output 450 Watt
Blows per Minute 0-4300 bpm

No Load Speed	0 - 1150 rpm
Impact energy (EPTA 05/2009)	2.2 J
Tool Holder	SDS-Plus
Max. Drilling Capacity [Wood]	30 mm
Max. Drilling Capacity [Metal]	13 mm
Max. Drilling Capacity [Concrete]	26 mm
Weight	3.8 kg
Hand/Arm Vibration - Drilling	7.1 m/s ²



**20MM L-SHAPE SDS-PLUS
ROTARY HAMMER**

D25052KT

Power Input 650 Watts
Power Output 300 Watts
Blows per Minute 0-6200 bpm

No Load Speed	0 - 2300 rpm
Impact energy (EPTA 05/2009)	1.9 J
Tool Holder	SDS-Plus
Max. Drilling Capacity [Wood]	30 mm
Max. Drilling Capacity [Metal]	13 mm
Max. Drilling Capacity [Concrete]	20 mm
Max. Drilling Capacity [Core bit]	50 mm
Weight	2.6 kg



**32MM HEAVY DUTY
SDS-PLUS COMBINATION HAMMER**

D25414KT

Power Input 1000 Watts
Power Output 650 Watts
Blows per Minute 0 - 4700 bpm



No Load Speed	0 - 820 rpm
Impact energy (EPTA 05/2009)	4.2 J
Tool Holder	SDS-Plus
Max. Drilling Capacity [Wood]	40 mm
Max. Drilling Capacity [Metal]	16 mm
Max. Drilling Capacity [Concrete]	6 - 32 mm
Max. Drilling Capacity [Core bit]	90 mm
Weight	4.3 kg



**45MM SDS-MAX
COMBINATION HAMMER**

D25601K

Power Input 1250 Watts
Power Output 615 Watt
Blows per Minute 1430 - 2840 bpm

Load Speed	210 - 415 rpm
Impact energy (EPTA 05/2009)	8 J
Tool Holder	SDS-Max
Max. Drilling Capacity [Concrete]	45 mm
Max. Drilling Capacity [Breakthrough bit]	65 mm
Max. Drilling Capacity [Core bit]	100 mm
Weight	6.8 kg



XLR® FULL HEAD CARBIDE BITS FOR SDS MAX® DRILLS



APPLICATIONS

Constructed with a single piece carbide head, with four main cutting faces. For use with SDS MAX drive hammer drills (Hilti type F, G, or Y)

FEATURES

- Maximum durability in hard concrete
- Increase carbide size & optimized tip design

XLR® FULL HEAD CARBIDE BITS FOR SDS PLUS® DRILLS

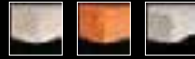

APPLICATIONS

Suitable for drilling plug & anchor holes in masonry, all types of stone and concrete.

FEATURES

- Solid carbide drill tip with optimised 4 cutter geometry offers the highdrill bit life and durability

EXTREME DeWALT® MASONRY DRILL BITS

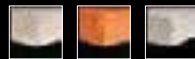

APPLICATIONS

Ideal for fixing or pipework clearance holes. Suitable for masonry, brick, stone, tiles and light concrete.

FEATURES

- Innovative Tip Design - unique design provides an efficient drilling action & reduced walking for greater accuracy



EXTREME® FOR SDS MAX® DRILLS

Cat. No.	Diameter [mm]	Length [mm]	Working Length [mm]
DT9400-QZ	12	340	200
DT9401-QZ	12	540	400
DT9402-QZ	12	670	550
DT9405-QZ	14	340	200
DT9406-QZ	14	540	400
DT9407-QZ	15	340	200
DT9408-QZ	15	540	400

XLR® FOR SDS MAX® DRILLS

Cat. No.	Diameter [mm]	Length [mm]	Working Length [mm]
DT60809-QZ	16	340	190
DT60810-QZ	16	540	390
DT60811-QZ	18	340	190
DT60812-QZ	18	540	390
DT60813-QZ	19	340	190
DT60814-QZ	19	540	390
DT60815-QZ	19	670	520
DT60816-QZ	20	340	210
DT60817-QZ	20	540	410
DT60818-QZ	20	920	790
DT60819-QZ	22	340	210
DT60820-QZ	22	540	410
DT60821-QZ	22	920	790
DT60822-QZ	24	340	210
DT60823-QZ	24	540	410
DT60824-QZ	25	340	210
DT60825-QZ	25	540	410
DT60826-QZ	25	920	790
DT60827-QZ	26	340	210
DT60828-QZ	26	540	410
DT60829-QZ	28	380	250
DT60830-QZ	28	570	440
DT60831-QZ	28	670	540
DT60832-QZ	30	380	250
DT60833-QZ	30	570	440
DT60834-QZ	32	380	250
DT60835-QZ	32	570	440
DT60836-QZ	32	920	790
DT60837-QZ	35	380	250
DT60838-QZ	35	570	440
DT60839-QZ	35	670	540
DT60840-QZ	36	570	430
DT60841-QZ	38	380	240
DT60842-QZ	38	570	440
DT60843-QZ	38	670	530
DT60844-QZ	40	380	240
DT60845-QZ	40	570	440
DT60846-QZ	40	920	730
DT60847-QZ	42	570	430

XLR® FOR SDS PLUS® DRILLS

Cat. No.	Diameter [mm]	Length [mm]	Working Length [mm]
DT8907-QZ	5	110	50
DT8908-QZ	5	160	100
DT8909-QZ	5	210	150
DT8910-QZ	5.5	110	50
DT8911-QZ	5.5	160	100
DT8912-QZ	6	110	50
DT8913-QZ	6	160	100
DT8914-QZ	6	210	150
DT8915-QZ	6	260	200
DT8916-QZ	6.5	160	100
DT8917-QZ	6.5	210	150
DT8918-QZ	6.5	260	200
DT8919-QZ	6.5	310	250
DT8920-QZ	7	160	100
DT8921-QZ	7	210	150
DT8922-QZ	8	110	50
DT8923-QZ	8	160	100
DT8924-QZ	8	210	150
DT8925-QZ	8	260	200
DT8926-QZ	8	310	250
DT8927-QZ	8	460	400
DT8928-QZ	10	160	100
DT8929-QZ	10	210	150
DT8930-QZ	10	260	200
DT8931-QZ	10	310	250
DT8932-QZ	10	460	400
DT8933-QZ	12	160	100
DT8934-QZ	12	200	150
DT8935-QZ	12	260	200
DT8936-QZ	12	310	260
DT8937-QZ	12	460	410
DT8938-QZ	14	160	100
DT8939-QZ	14	200	150
DT8940-QZ	14	260	200
DT8941-QZ	14	310	250
DT8942-QZ	14	460	400

EXTREME® DRILL BITS

Cat. No.	Diameter [mm]	Length [mm]	Working Length [mm]
DT6695-QZ	3	110	70
DT6671-QZ	4	75	50
DT6672-QZ	5	85	50
DT6673-QZ	5	150	100
DT6674-QZ	5.5	85	50
DT6675-QZ	6	100	60
DT6676-QZ	6	150	100
DT6677-QZ	6	200	150
DT6678-QZ	6.5	100	60
DT6679-QZ	6.5	150	100
DT6680-QZ	7	100	60
DT6681-QZ	7	150	100
DT6682-QZ	8	120	80
DT6683-QZ	8	200	150
DT6684-QZ	9	120	80
DT6685-QZ	10	120	80
DT6686-QZ	10	200	150
DT6687-QZ	12	150	100
DT6688-QZ	12	200	150
DT6689-QZ	13	150	100
DT6690-QZ	14	150	100
DT6691-QZ	14	200	150
DT6692-QZ	16	150	100
DT6693-QZ	16	200	150



TECHNICAL SUPPORT

This catalogue has been designed to help you select the best **DEWALT** anchor or fastener for your application, but if you need a more detailed specification please refer to the **DEWALT Technical Manual** (available in English and German). This provides comprehensive product information including:

- **Easy-to-follow installation instructions**
- **Detailed load capacities**
- **Materials specifications**

We also recommend that you use the **DEWALT Design Assist** software that provides all the information you need for the efficient calculation of single and multiple anchor connections.



**FOR MORE INFORMATION VISIT
WWW.DEWALTDESIGNASSIST.COM**

Innovation has always been a core strength of DEWALT and since its foundation has been delivering innovative anchoring solutions for attachment to concrete, masonry, steel and wood.

DEWALT employs a large team of senior anchor design and test engineers at our state-of-the-art laboratories and their expertise together with the massive engineering resources of Stanley Black & Decker ensures that we provide innovative, high-quality anchoring solutions.

In-house QC inspection and testing procedures by our experienced technical personnel ensure that only the highest quality fasteners enter the market place.



MANUFACTURING QUALITY WITH ETA APPROVALS

To ensure maximum performance, **DEWALT** fasteners undergo the most rigorous manufacturing and testing procedures. As a result, many have received some of the world's most demanding approvals including ETA and ICC ES certification.

To find out which products have approvals please refer to the table opposite or see the relevant product page. For full technical information and to download the relevant approval and certification documentation please visit www.DEWALT.com.



1. The last two digits of the year in which the CE marking was issued
2. CE Certificate of conformity reference
3. European technical approval number
4. Guideline number for technical approval

POST-INSTALLED REBAR

To meet ETA approval, all post-installed rebar applications can only be undertaken by a fully trained and certified user, using the tools supplied in a **DEWALT** rebar case.

This can be obtained after full training and certification has been undertaken.

For more information, contact your local representative.



Anchor products hold a **European Technical Approval (ETA)** and are qualified according to one of the following technical guidelines:

- ETAG 001 for metal anchors installed in concrete. (Option 1 for cracked concrete, Option 7 for uncracked concrete, Part 6 for multiple use for non-structural applications).
- ETAG 029 for injection anchors installed in masonry.
- EOTA TR 023 for post-installed reinforcement bars.

Products complying with European standards or approvals are marked with the **CE Marking**.



A **fire resistance rating** provides the duration of fire exposure for which the anchor product is qualified:

- EOTA TR 020 for the evaluation of anchors installed in concrete.



The **German Technical Approval** of post installed reinforcement bars certifies that the product meets the requirements to be installed by trained personnel. The German Technical Approvals are, next to the European Technical Approvals, regarded as the most renowned qualifications of anchor products.



The **Evaluation Service of the International Code Council (ICC ES)** provides test guidelines for anchor qualification in the US. The ICC-Evaluation reports granted on the basis of their acceptance criteria are internationally recognised and provide a high degree of safety.



The **National Sanitation Foundation (NSF) International** is an independent organisation that provides standards for e.g. product certification for public health and the environment.























Products tested for the emission of volatile substances in indoor air, with a risk of inhalation toxicity, on a scale ranging from class A + (very low emissions) to C (high emissions) level.







Product is approved for seismic load applications.

For comprehensive specification and installation instructions, please refer to the **DEWALT** Technical Manual or contact your local customer service team for more assistance.

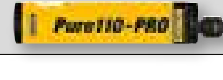
LISTINGS AND APPROVALS						
European Technical Approval	Fire Rating	ICCES (AC)	NSF / WQA	VOC	German Technical Approval	Seismic Approval

MECHANICAL ANCHORS	PRODUCT										
		BLUE-TIP SCREWBOLT - HEX HEAD	23	✓	✓						
		BLUE-TIP SCREWBOLT - COUNTERSUNK	25	✓							
		PTB-PRO HEAVY DUTY THROUGHBOLT	27	✓	✓						✓
		PTB-SS-ETA1-PRO HEAVY DUTY THROUGHBOLT	28	✓	✓						
		SNAKE SELF TAPPING ANCHOR	32	✓	✓	✓					
		DM-LIP-PRO DROP-IN ANCOR	33	✓	✓						
		DM-PRO DROP-IN ANCOR	33	✓	✓						
		DM-SS-PRO DROP-IN ANCOR	34	✓	✓						
		TAPPER-PRO SCREWS	36			✓					
		PBZ-PRO STEEL WEDGE NAILS	39	✓	✓						
		BSC-PBZ-PRO STEEL WEDGE NAILS	39	✓	✓						
		PRO NYLON HAMMER SCREWS	42	✓							

ADHESIVE ANCHORS		PURE150-PRO	Concrete	48	✓	✓	✓	✓	✓		✓	
			Core-drilled concrete	48	✓	✓	✓	✓	✓			
			Post-installed rebar	48	✓	✓		✓	✓	✓		
		PURE110-PRO	Concrete	49	✓	✓	✓	✓	✓		✓	
		AC100-PRO	Concrete	51	✓	✓	✓	✓	✓		✓	
			Masonry	51	✓			✓	✓			
			Post-installed rebar	51	✓	✓		✓	✓	✓		
		PV50-PRO	Concrete	53	✓				✓			
		PV45-PRO	Concrete	54	✓				✓			
			Masonry	54	✓				✓			
	SC-PRO	Concrete	55	✓								

DIRECT FASTENING		C5 TRAK-IT XH NAILS	74	✓	✓					
		C3 TRAK-IT XH NAILS	75		✓					



ONLINE ANCHOR DESIGN SOFTWARE

CALCULATIONS AND SPECIFICATION FOR CONSTRUCTION

- Fully featured and easy to use web-based interface
- Easy 5 step anchor design with 3D modelling of fastening
- Professional specification of **DEWALT** fastenings to ETA guidelines
- Customised anchor design facility

**KEEP PACE WITH CHANGING
CONSTRUCTION ENVIRONMENTS
WITH DEWALT DESIGN ASSIST.**

**FOR MORE INFORMATION VISIT
www.DEWALTDDESIGNASSIST.COM**

DDA

DEWALT DESIGN ASSIST





DEWALT®

**DIRECT
FASTENING TOOLS**

**1 YEAR
FULL
WARRANTY**

**DEWALT OFFERS
AN OUTSTANDING
GUARANTEE.**

In the unlikely event that your **DEWALT** tool becomes defective due to faulty materials or workmanship within 12 months of purchase, **DEWALT** guarantees to replace all defective parts free of charge or - at our discretion - replace the unit free of charge.

In order to make a claim, you will need to submit proof of purchase to the seller or an authorised **DEWALT** repair agent, and the product must display the CE mark, as shown below.

This is provided that the product has not been misused and has been subject to fair wear and tear. Any attempt by anyone other than an authorised service repair agent to service a tool during the warranty period will invalidate the warranty for said tool.

DEWALT	DDF2120400	PA3500 Caliber 6.8/11
DeWALT, Richard Klinger Str. 11, D-65510, Idstein, Germany		Type 1 Class A Made in China Rev.1 N389741 www.DeWALT.eu

BASE MATERIALS QUICK REFERENCE GUIDE	15
CATALOGUE NUMBER REFERENCE GUIDE	16

MECHANICAL ANCHORS

HIGH LOAD ANCHORS

BLUETIP SCREWBOLTS™	22
PTB UNIVERSAL HEAVY DUTY THROUGH BOLTS	26
FHS FIXED HEAD SLEEVE ANCHORS	29
SHIELD ANCHORS	30
TW TIE WIRE HANGERS	31
SNAKE SELF-TAPPING ANCHORS	32
DM DROP-IN ANCHORS & SETTING TOOLS	33
VERTIGO™ CONCRETE VERTICAL HANGERS	35

MEDIUM & LIGHT LOAD ANCHORS

TAPPER-PRO SCREWS	36
SPIKE MUSHROOM HEAD SPIKES	38
SPIKE TIE WIRE SPIKES	38
PBZ STEEL WEDGE NAILS	39
EXPRESS NAIL CEILING CLIPS	40
EXPRESS NAIL FIXINGS	40
ISO METAL INSULATION FIXINGS	41
PRO NYLON HAMMER SCREWS	42
NYLON HAMMER SCREWS	43
MFA METAL FRAME ANCHORS	44
WINDOW SCREWS	45

ADHESIVE ANCHORS

CARTRIDGE SYSTEMS

PURE150-PRO	48
PURE110-PRO	49
AC100-PRO	50
AC100-NORDIC	52
PV50-PRO	53
PV45-PRO	54

CAPSULE SYSTEM

SC-PRO	55
--------------	----

ACCESSORIES & THREADED RODS

NOZZLES	56
PISTON PLUGS	56
PUMP	57
BRUSHES	57
STEEL BRUSHES AND SDS EXTENSIONS	57
PLASTIC & MESH SLEEVES	58
THREADED RODS	59

LIGHT DUTY ANCHORS

LIGHT DUTY ANCHORS, TOGGLES & PLUGS

ZIP-IT® PLASTERBOARD ANCHORS	62
ZIPTOGGLE® WITH SCREWS	62
LEGS® WALL ANCHORS	63
ST STRAP TOGGLE™	63
WALL-DOG™ SCREW ANCHORS	64
HWA HOLLOW WALL ANCHORS	65
NP NYLON PLUGS	66
SHARKIET™ PLASTIC WALL ANCHORS	67
AERATED CONCRETE ANCHORS	68
PX UNIVERSAL PLUGS	69

DIRECT FASTENING

GAS TOOLS, ACCESSORIES & NAILS

C5 TRAK-IT® GAS NAILER & ACCESSORIES	72
C5 TRAK-IT® STICK-E CLIPS & WASHERS	73
C5 TRAK-IT® NAILS & XH NAILS	74
C3 TRAK-IT® ACCESSORIES	75
C3 TRAK-IT® NAILS & XH NAILS	75

POWDER ACTUATED TOOLS, ACCESSORIES PINS & CLIPS

P3X POWDER ACTUATED NAILER	76
P3X PINS	76
PA3500 POWDER ACTUATED NAILER	77
PA3500 / P3X PINS & CLIPS	78
POWDER ACTUATED STRIP NAILS	80

SCREWS

COLLATED DRYWALL SCREWS.....	81
------------------------------	----



BASE MATERIALS QUICK REFERENCE GUIDE



Uncracked concrete



Solid brick/masonry



Lightweight concrete



Metal profile



Cracked concrete



Hollow brick



Aerated concrete



Chipboard



Hollow-core concrete slabs



Sand-lime stone solid



Gypsum board



Wood



Natural stone



Perforated sand-lime stone



Gypsum block



Steel

DISCLAIMER FOR RECOMMENDATIONS, INFORMATION AND USE OF DATA

The recommendations, information and data contained in this manual are put together with the greatest care and accuracy possible. It is based on principles, equations and safety factors set out in the technical documentation of DeWALT Anchors & Fasteners, Inc. that are believed to be correct and current as of April 1, 2015. The information and data is subject to change after such date as DeWALT Anchors & Fasteners, Inc. reserves the right to change the designs, materials and specifications of the products in this manual without notice.

It is the responsibility of the design professional to ensure that a suitable product is selected, properly designed and used in the intended application. This includes that the selected product and its use is compliant with the applicable building codes and other legal requirements and will satisfy

durability and performance criteria and margins of safety which they determine are applicable. The products must be used, handled, applied and installed strictly in accordance with all current instructions for use published by DeWALT Anchors & Fasteners, Inc.

The performance data given in this manual are the result of the evaluation of tests conducted under laboratory conditions. It is the responsibility of the designer and installer in charge to consider the conditions on site and to ensure the performance data given in the manual is applicable to the actual conditions. In particular the base material and environmental conditions have to be checked prior to installation. In case of doubt, contact the technical support of DeWALT Anchors & Fasteners, Inc.

Cat. No.	Page	Cat. No.	Page	Cat. No.	Page	Cat. No.	Page
DDF1220100	76	DDF6120200	75	DFC1670400	57	DFM1110510	27
DDF1220200	76	DDF6120250	75	DFC1670450	57	DFM1110520	27
DDF1350000	77	DDF6310000	74	DFC1670500	57	DFM1110540	27
DDF1350050	77	DDF6310100	74	DFC1670550	57	DFM1110560	27
DDF1350100	77	DDF6310150	74	DFC1670600	57	DFM1110580	27
DDF2120400	77	DDF6320020	75	DFC1690000	56	DFM1110600	27
DDF2130000	76	DDF6320100	75	DFC1690050	56	DFM1110620	27
DDF2230000	76	DDF6320170	75	DFC1690150	56	DFM1110640	27
DDF3000050	78	DDF6710000	73	DFC1690250	56	DFM1110660	27
DDF3000100	78	DDF6710050	73	DFC1690300	56	DFM1110680	27
DDF3000150	78	DDF6750000	73	DFC1690350	56	DFM1110700	27
DDF3000200	78	DDF6750050	73	DFC1690400	56	DFM1110720	27
DDF3000250	78	DFC1110000	48	DFC4130000	59	DFM1110730	27
DDF3000300	78	DFC1110050	48	DFC4130050	59	DFM1110740	27
DDF3000350	78	DFC1110100	48	DFC4130100	59	DFM1110760	27
DDF3000400	78	DFC1130000	49	DFC4130150	59	DFM1110780	27
DDF3000450	78	DFC1130050	49	DFC4130200	59	DFM1110800	27
DDF3000500	78	DFC1210200	51	DFC4130250	59	DFM1110810	27
DDF3000550	78	DFC1230000	51	DFC4150000	59	DFM1110830	27
DDF3010000	78	DFC1230050	51	DFC4150050	59	DFM1110870	27
DDF3060000	78	DFC1230100	51	DFC4150100	59	DFM1110880	27
DDF3060050	78	DFC1230150	51	DFC4150150	59	DFM1110900	27
DDF3080000	78	DFC1250000	52	DFC4150200	59	DFM1110920	27
DDF3080050	78	DFC1310000	53	DFC4150250	59	DFM1110940	27
DDF3410050	80	DFC1310100	53	DFC4170000	59	DFM1110960	27
DDF3410100	80	DFC1310150	53	DFC4170040	59	DFM1110980	27
DDF3410150	80	DFC1320000	54	DFC4170160	59	DFM1140000	28
DDF3410200	80	DFC1510000	55	DFC4170200	59	DFM1140020	28
DDF3410250	80	DFC1510050	55	DFC4170320	59	DFM1140050	28
DDF3410300	80	DFC1510100	55	DFC4170400	59	DFM1140190	28
DDF3410350	80	DFC1510150	55	DFC4710000	58	DFM1140200	28
DDF3410400	80	DFC1510200	55	DFC4710050	58	DFM1140220	28
DDF3410450	80	DFC1510250	55	DFC4710100	58	DFM1140250	28
DDF3410500	80	DFC1510300	55	DFC4720000	58	DFM1140270	28
DDF3430000	80	DFC1610000	49,51,53, 54	DFC4720050	58	DFM1140300	28
DDF3440000	76	DFC1610050	51,53	DFC4730000	58	DFM1140310	28
DDF3440050	76	DFC1610100	51,52,53	DFC4730050	58	DFM1140350	28
DDF3440100	76	DFC1610150	51,52,53	DFC4730100	58	DFM1140360	28
DDF3440150	76	DFC1610150	53	DFM1110000	27	DFM1140400	28
DDF3440200	76	DFC1610200	48	DFM1110010	27	DFM1140430	28
DDF3440250	76	DFC1610300	49	DFM1110020	27	DFM1140450	28
DDF3440300	76	DFC1610350	48	DFM1110040	27	DFM1140480	28
DDF3440350	76	DFC1630000	51	DFM1110050	27	DFM1140500	28
DDF4020100	79	DFC1630050	48	DFM1110060	27	DFM1140530	28
DDF5110500	73	DFC1630250	51,52,53	DFM1110070	27	DFM1140550	28
DDF5120550	73	DFC1630500	48	DFM1110080	27	DFM1140600	28
DDF5140500	73	DFC1640200	56	DFM1110100	27	DFM1140700	28
DDF5150500	73	DFC1640250	56	DFM1110120	27	DFM1140750	28
DDF5150550	73	DFC1640300	56	DFM1110140	27	DFM1140800	28
DDF5260000	73	DFC1640350	56	DFM1110160	27	DFM1140850	28
DDF5330000	75	DFC1640450	56	DFM1110180	27	DFM1140870	28
DDF5610500	73	DFC1640500	56	DFM1110200	27	DFM1140900	28
DDF5610500	75	DFC1650050	57	DFM1110220	27	DFM1140930	28
DDF5610510	73	DFC1660000	57	DFM1110230	27	DFM1140950	28
DDF5610510	75	DFC1660050	57	DFM1110250	27	DFM1150050	29
DDF5610520	73	DFC1660100	57	DFM1110260	27	DFM1150080	29
DDF5610520	75	DFC1670000	57	DFM1110280	27	DFM1150120	29
DDF6110000	74	DFC1670050	57	DFM1110320	27	DFM1150160	29
DDF6110050	74	DFC1670100	57	DFM1110340	27	DFM1150230	29
DDF6110100	74	DFC1670150	57	DFM1110360	27	DFM1150250	29
DDF6110150	74	DFC1670200	57	DFM1110400	27	DFM1150280	29
DDF6110200	74	DFC1670250	57	DFM1110440	27	DFM1150320	29
DDF6110250	74	DFC1670300	57	DFM1110460	27	DFM1150360	29
DDF6120000	75	DFC1670350	57	DFM1110480	27	DFM1150440	29

Cat. No.	Page	Cat. No.	Page	Cat. No.	Page	Cat. No.	Page
DFM1150580	29	DFM2100110	34	DFM2450500	30	DFM3510050	44
DFM1150620	29	DFM2100150	34	DFM2450520	30	DFM3510100	44
DFM1150640	29	DFM2100160	34	DFM2450540	30	DFM3510150	44
DFM1150660	29	DFM2100200	34	DFM2450560	30	DFM3510250	45
DFM1150680	29	DFM2100210	34	DFM2450580	30	DFM3510300	45
DFM1150730	29	DFM2100250	34	DFM2450600	30	DFM3510350	45
DFM1150780	29	DFM2100260	34	DFM2450620	30	DFM3510400	45
DFM1150810	29	DFM2110000	33	DFM2450640	30	DFM3510450	45
DFM1150830	29	DFM2110100	33	DFM2450660	30	DFM3510500	45
DFM1150850	29	DFM211010S	33	DFM3110000	38	DFM3520350	45
DFM1150860	29	DFM2110150	33	DFM3110240	38	DFM3520400	45
DFM1210390	29	DFM211015S	33	DFM3110280	38	DFM3520450	45
DFM1210450	29	DFM2110200	33	DFM3130000	40	DFM3520500	45
DFM1210480	29	DFM211020S	33	DFM3130050	40	DFM3520550	45
DFM1210510	29	DFM2110250	33	DFM3130100	40	DFM3520650	45
DFM1210540	29	DFM2110300	33	DFM3130150	40	DFM4110000	62
DFM1210570	29	DFM2110500	33	DFM3130200	40	DFM4120000	62
DFM1210600	31	DFM2110550	33	DFM3130250	40	DFM424000P	64
DFM1410000	23	DFM211055S	33	DFM3130300	40	DFM424015P	64
DFM1410030	23	DFM2110600	33	DFM3130350	40	DFM425000P	64
DFM1410050	23	DFM211060S	33	DFM3130400	40	DFM425005P	64
DFM1410070	23	DFM2110650	33	DFM3130450	40	DFM4400000	65
DFM141007S	23	DFM211065S	33	DFM3130500	40	DFM4410050	65
DFM1410090	23	DFM2110700	33	DFM3150000	41	DFM4410150	65
DFM141011S	23	DFM2110750	33	DFM3150050	41	DFM4410200	65
DFM1410130	23	DFM2120000	34	DFM3150100	41	DFM4410300	65
DFM1410180	23	DFM2120050	34	DFM3150150	41	DFM4460050	67
DFM1410210	23	DFM2120100	34	DFM3210000	43	DFM4460100	67
DFM1410240	23	DFM2120150	34	DFM3210050	43	DFM4470000	63
DFM141024S	23	DFM2120200	34	DFM321005S	43	DFM4540050	63
DFM1410280	23	DFM2120250	34	DFM321006S	43	DFM4540100	63
DFM1410320	23	DFM2200050	35	DFM321007S	43	DFM4570000	62
DFM141032S	23	DFM2200100	35	DFM3210100	43	DPA2110000	37
DFM1410360	23	DFM2220000	35	DFM321010S	43	DPA2110050	37
DFM141036S	23	DFM2220050	35	DFM3210150	43	DPA2110100	37
DFM1410430	23	DFM2220100	35	DFM321015S	43	DPA2110150	37
DFM1410450	23	DFM2300000	32	DFM321018S	43	DPA2110200	37
DFM1410480	23	DFM2300050	32	DFM3210200	43	DPA2110250	37
DFM1410510	23	DFM2300100	32	DFM3210250	42	DPA2110300	37
DFM1410540	23	DFM2310000	32	DFM3210450	42	DPA2110350	37
DFM1410580	23	DFM2310050	32	DFM3310000	39	DWF4000250	81
DFM1410650	23	DFM2310100	32	DFM3310050	39	DWF4000350	81
DFM1410680	23	DFM2450000	31	DFM3310100	39	DWF4000450	81
DFM1410710	23	DFM2450020	31	DFM3310150	39	DWF4000550	81
DFM1410770	23	DFM2450040	31	DFM3420000	42	DWF4100350	81
DFM1410800	23	DFM2450060	31	DFM3420100	42	DWF4100450	81
DFM1410830	23	DFM2450120	30	DFM3420150	42	DWF4100550	81
DFM1410860	23	DFM2450140	30	DFM3420250	42	DWT1400100	36
DFM1410890	23	DFM2450160	30	DFM3420300	42	DWT1400150	36
DFM1420000	24	DFM2450180	30	DFM3420350	42	DWT1400200	36
DFM1420030	24	DFM2450200	30	DFM3420400	42	DWT1400250	36
DFM1420060	24	DFM2450220	30	DFM3440000	66	DWT1400300	36
DFM1420090	24	DFM2450240	30	DFM3440050	66	DWT1410100	36
DFM1420330	25	DFM2450260	30	DFM3440150	66	DWT1410150	36
DFM1420420	25	DFM2450280	30	DFM3440200	66	DWT1410200	36
DFM1420480	25	DFM2450300	30	DFM3440250	66	DWT1410250	36
DFM1420510	25	DFM2450320	30	DFM3440300	66	DWT1410300	36
DFM1420570	25	DFM2450340	30	DFM3450100	68	DWT1410400	36
DFM1420600	25	DFM2450360	30	DFM3450200	68	DWT1410450	36
DFM2100000	34	DFM2450400	30	DFM3450300	68	DWT1410650	36
DFM2100010	34	DFM2450420	30	DFM3460000	69	DWT1410700	36
DFM2100050	34	DFM2450440	30	DFM3460050	69	DWT1410850	36
DFM2100060	34	DFM2450460	30	DFM3460100	69		
DFM2100100	34	DFM2450480	30	DFM3510000	44		

**MECHANICAL
ANCHORS**



QUALITY AND RELIABILITY - BUILT IN.

The **DEWALT** range of mechanical anchors has been developed to provide dependable options for construction professionals.

Featuring an extensive selection of expansion bolts, concrete screws and expansion sockets, the range provides an ideal fastening solution for everything from fixed steelwork supports and high load construction to demountable fixtures.

QUALITY FINISHES FOR ANY APPLICATION

Ranging from zinc plated to stainless steel, the quality of materials play a large part in ensuring **DEWALT** fasteners deliver enhanced performance whatever the application.



ZINC PLATED



HOT DIP GALVANISED



STAINLESS STEEL

CHOOSING THE RIGHT MECHANICAL ANCHOR

Aside from loading calculations, the right product selection can be influenced by the particular application, whether the fixing is permanent or removable and what the edge distance and embedment depth need to be.

FIXED OR REMOVABLE OPTIONS



For some installations, it may be necessary to create a mounting point where the anchor needs to be removed afterwards. A drop in anchor provides a fixed socket for threaded rods whereas bolts such as **Blue-Tip™** can be inserted and easily removed as required.

EXPANSION ANCHORS

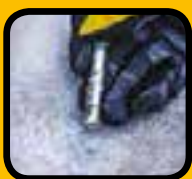

Utilising an expansion component, either at the base of the hole or along the length of the anchor, **DEWALT** expansion anchors can be used to carry high loads. Because they work by friction with the base material to provide grip, they impart expansion stresses into the base substrate. Care should always be taken to work within edge distance and spacing tolerances to ensure a secure fixing.

THROUGH OR PREPOSITIONED FIXINGS



If using a through fixing, the fixture can be used as a template, and the fixing made through nominal clearance holes without the need for the object to be removed.

Alternatively, without a through fixing, the fixture position must be marked then removed as the hole is drilled.

SCREW ANCHORS



Screw anchors can provide an instant fix for metal and timber fixtures onto concrete, block and brickwork. Once the pilot hole is drilled, the anchor can be driven in using an impact wrench or hand socket wrench and can also be removed quickly and easily.

DROP IN ANCHORS



Ideal for creating a demountable fixture in concrete and other base materials, drop in anchors are available in a wide range of diameters. They are easy to set with an appropriate **DEWALT** setting tool to provide a secure mounting for threaded rods or bolt. Ideal for overhead fixtures, the anchor remains in situ, but can be skimmed or covered if not required.















MECHANICAL ANCHORS – SELECTION GUIDE

This selection guide gives an overview of the mechanical fasteners range including an indication of load capabilities, ETA approval and suitable base materials.

For more information on each product please refer to the specific product page. For comprehensive load data and installation data please refer to the **DEWALT** Technical Manual.

Suitable May be suitable depending on application						
Product			< 2kN	< 2kN - 15kN	> 15kN	ETA **
BLUE-TIP SCREWBOLTS™ - HEX HEAD	23					
BLUE-TIP SCREWBOLTS™ - DOME / PAN HEAD	24					
BLUE-TIP SCREWBOLTS™ - COUNTERSUNK HEAD	25					
HEAVY DUTY THROUGH BOLTS – PTB-PRO	27					
HEAVY DUTY THROUGH BOLTS – PTB-SS-ETA1-PRO	28					
HEAVY DUTY THROUGH BOLTS – PTB-G	29					
FHS FIXED HEAD SLEEVE ANCHORS	29					
SHIELD ANCHORS – SAP PROJECTING BOLT	30					
SHIELD ANCHORS – SAL LOOSE BOLT BOLT	30					
SHIELD ANCHORS – SA SHIELD ONLY	31					
TW WIRE HANGERS	31					
SNAKE INTERNAL THREAD SELF-TAPPING ANCHORS	32					
DM-DROP IN ANCHORS (ALL TYPES)	33-34					
VERTIGO™ CONCRETE VERTICAL HANGERS	35					
TAPPER-PRO SCREWS (ALL TYPES)	36					
SPIKE® MUSHROOM HEAD SPIKE	38					
SPIKE® TIE WIRE SPIKE	38					
PBZ-PRO & BSC-PBZ-PRO STEEL WEDGE NAIL	39					
EXPRESS NAIL CEILING CLIP	40					
EXPRESS NAIL FIXING	40					
ISO METAL INSULATION FIXING	41					
PRO NYLON HAMMER SCREWS	42					
NYLON HAMMER SCREWS	43					
MFA METAL FRAME ANCHORS	44					
PS & PSZ WINDOW SCREWS	45					

*Only for redundant systems **ETA approval may not apply to all sizes. Refer to product page for more information.

BASE MATERIAL														
Uncracked concrete	Cracked concrete	Hollow-core concrete slabs	Natural stone	Solid brick/masonry	Hollow brick	Sand-limestone solid	Perforated sand-lime stone	Lightweight concrete	Aerated concrete	Gypsum board	Gypsum block	Chipboard	Wood	
														
✓	✓	✓	✓	✓		✓	✓	✓						
✓*	✓	✓	✓	✓		✓	✓	✓						
✓	✓	✓	✓	✓		✓	✓	✓						
✓	✓		✓											
✓			✓											
✓			✓											
✓		✓		✓		✓								
✓		✓		✓		✓								
✓		✓		✓		✓								
✓		✓		✓		✓								
✓		✓		✓		✓								
✓		✓		✓		✓								
✓		✓		✓		✓								
✓	✓		✓	✓		✓		✓	✓					
✓	✓*													
✓		✓		✓		✓								
✓		✓	✓	✓	✓	✓	✓	✓	✓	✓	✓	✓	✓	
✓		✓	✓	✓		✓								
✓		✓	✓	✓		✓								
✓		✓	✓	✓		✓								
✓		✓	✓	✓		✓								
✓		✓	✓	✓		✓								
✓		✓	✓	✓		✓								
✓		✓	✓	✓		✓								
✓		✓	✓	✓		✓								
✓		✓	✓	✓		✓								
✓		✓	✓	✓	✓	✓	✓	✓	✓				✓	

DUST RELIEF THREAD FOR LOW INSTALLATION TORQUE

EXTENDED THREAD ENSURES EXTRA HOLD IN CONCRETE

SUITABLE FOR SMALL EDGE DISTANCES

ONE PIECE DESIGN FOR EASY INSTALLATION

BLUE-TIP SCREWBOLTS™

ONE PIECE DESIGN WITH IMMEDIATE HIGH STRENGTH LOADING.

Blue-Tip screwbolts are one-piece heavy duty concrete screws with ETA Option 1 approval*.

They are simple to install and provide a strong, secure hold for high load applications and small edge distances, making it the preferred choice for a fast, reliable installation into a variety of substrates.

The anchors are designed with a dust relief thread that allows for low installation torque, are fully removable and are designed to resist structural and non-structural loading in cracked and uncracked concrete.

- ETA Option 1 approved for cracked and uncracked concrete*
- Approved for small edge distances
- One piece design for easy installation
- Dust relief thread allows for low installation torque

The range includes four different head types in lengths from 30-280mm making it an extremely versatile mechanical anchoring system.

*diameter 10 mm to 16 mm, hex head and countersunk

HEX HEAD



DOME HEAD



PAN HEAD



COUNTERSUNK



BLUE-TIP SCREWBOLTS™

APPLICATIONS

- Racking and shelving
- Temporary supports
- Fencing
- Railings and handrails
- Stadium seating
- Fastening steel and metal base plates to concrete

MATERIALS

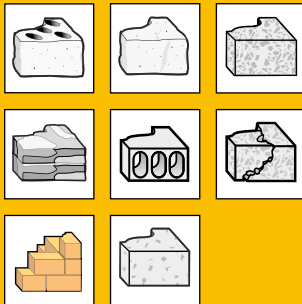

See page 15 for details.

APPROVALS









HEX HEAD - ZINC PLATED

Drill Dia. 5-6 mm

Drill Dia. 8-16 mm



Cat No.								List Price per Box
Cat No.		Drill Dia. [mm]	Length [mm]	Head Size [mm]	Max f _{ix} [mm]	Box Quantity	Carton Quantity	List Price per Box
DFM1410000			5 x 50	7	15	100	800	£9.29
DFM1410030			6 x 30	10	5	100	800	£10.00
DFM1410050			6 x 50	10	15	100	800	£18.55
DFM141007S			6 x 60	10	25	50	400	£11.43
DFM1410070			6 x 60	10	25	100	800	£19.05
DFM1410090			6 x 80	10	35	50	400	£14.15
DFM141011S			6 x 100	10	55	50	400	£14.52
DFM1410130			6 x 120	10	75	100	400	£29.76
DFM1410180			8 x 50	13	5	50	400	£10.95
DFM1410210			8 x 75	13	10	50	200	£12.65
DFM141024S			8 x 100	13	35	25	100	£10.46
DFM1410240			8 x 100	13	35	50	200	£17.43
DFM1410280	•		10 x 60	17	5	50	200	£17.86
DFM141032S	•		10 x 75	17	20	25	200	£12.57
DFM1410320	•		10 x 75	17	20	50	200	£20.95
DFM141036S	•		10 x 100	17	45	25	100	£15.72
DFM1410360	•		10 x 100	17	45	50	200	£26.19
DFM1410430	•		10 x 120	17	65	25	100	£15.60
DFM1410450	•		10 x 140	17	85	25	100	£18.75
DFM1410480	•		10 x 160	17	105	20	80	£18.57
DFM1410510	•		10 x 200	17	145	20	80	£23.33
DFM1410540	•		10 x 240	17	185	20	80	£31.67
DFM1410580	•		10 x 280	17	225	20	80	£36.67
DFM1410650	•		12 x 75	19	5	25	100	£17.26
DFM1410680	•		12 x 100	19	30	25	100	£20.24
DFM1410710	•		12 x 150	19	80	20	80	£24.76
DFM1410770	•		16 x 100	23	20	20	80	£39.90
DFM1410800	•		16 x 130	23	50	10	40	£21.43
DFM1410830	•		16 x 150	23	70	10	40	£23.10
DFM1410860	•		16 x 200	23	120	10	40	£30.00
DFM1410890	•		16 x 240	23	160	10	40	£40.48

BLUE-TIP SCREWBOLTS™

APPLICATIONS

- Fencing
- Handrails
- Ornamental steelwork



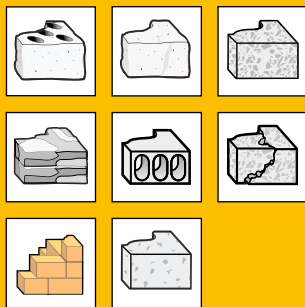



MATERIALS

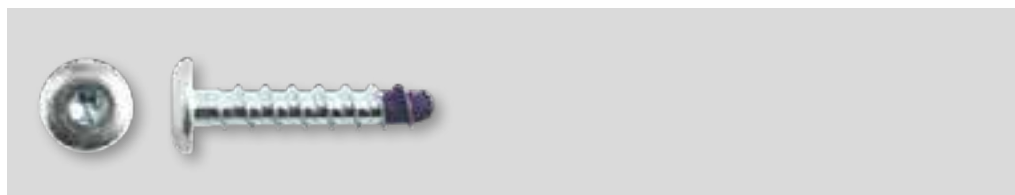

See page 15 for details.







DOME HEAD - ZINC PLATED

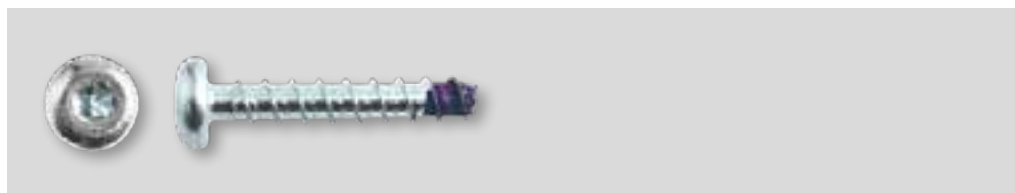

Cat No.		 Drill Dia. [mm]	 Length [mm]	 TORX [mm]	 Max t _{fix} [mm]	 Box Quantity	 Carton Quantity	List Price per Box
DFM1420000		6 x 40		T-30	10	100	800	£13.33
DFM1420030		6 x 50		T-30	15	100	800	£16.19
DFM1420060		6 x 65		T-30	20	100	800	£19.29

PAN HEAD - ZINC PLATED



Cat No.		 Drill Dia. [mm]	 Length [mm]	 TORX [mm]	 Max t _{fix} [mm]	 Box Quantity	 Carton Quantity	List Price per Box
DFM1420090		6 x 45		T-40	10	100	800	£14.76

BLUE-TIP SCREWBOLTS™

APPLICATIONS

- Temporary supports
- Window and door frame installations
- Mounting fixtures on walls
- Fixing wood to concrete and masonry

MATERIALS

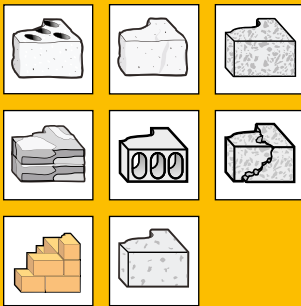







See page 15 for details.

APPROVALS



COUNTERSUNK - ZINC PLATED



Cat No.								List Price per Box
		Drill Dia. [mm]	Length [mm]	TORX / A/F [mm]	Max t _{fix} [mm]	Box Quantity	Carton Quantity	
DFM1420330		6 x 100	T-40	55	50	200	£19.64	
DFM1420420		8 x 100	6mm	35	50	200	£31.68	
DFM1420480	•	10 x 75	8mm	15	50	200	£26.19	
DFM1420510	•	10 x 100	8mm	45	50	200	£42.37	
DFM1420570	•	12 x 100	10mm	30	25	100	£31.96	
DFM1420600	•	12 x 150	10mm	80	20	80	£36.67	

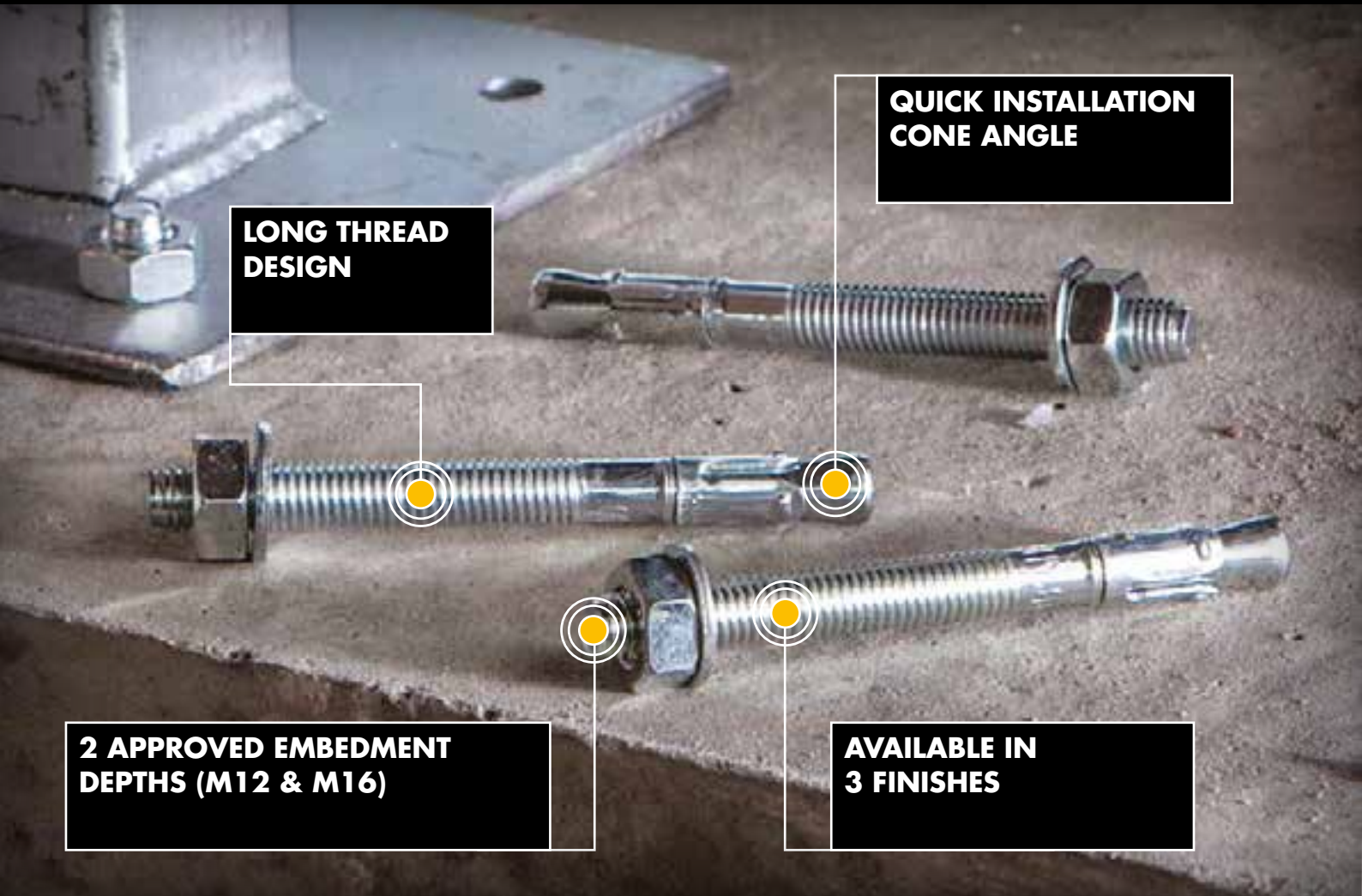

PTB UNIVERSAL HEAVY DUTY THROUGH BOLTS

CRACKED CONCRETE THROUGH BOLT APPROVED FOR FLEXIBLE EMBEDMENTS.

The PTB-PRO is a fully threaded, torque controlled, wedge expansion anchor designed for consistent performance in cracked and uncracked concrete.

The anchor is easy to install and suitable for a variety of base materials with a nominal drill bit size the same as the anchor diameter. The wide range of available PTB-PRO anchor sizes also covers all common capacity demands with a superior load-displacement response that qualifies the PTB-PRO for both standard and adverse loading conditions.

- ETA Option 1 approval for cracked and uncracked concrete*
- Approved for seismic load applications (M8-M16)**
- Two approved embedment depths (M12 & M16)*
- Long thread for flexibility in fixture thicknesses
- Special cone angle for quick installation
- F120 fire resistance*

* PTB-PRO zinc plated & stainless steel ** PTB-PRO zinc plated



**PTB-PRO
ZINC PLATED**



**PTB-SS-ETA1-PRO
STAINLESS STEEL**



**PTB-G
HOT DIP GALVANISED**

PTB UNIVERSAL HEAVY DUTY THROUGH BOLTS

APPLICATIONS

- Piping & heating supports
- Heating pumps
- Ventilation systems & air conditioning
- Safety barriers
- Fire escapes

MATERIALS



See page 15 for details.

APPROVALS



PTB-PRO - ZINC PLATED



Cat No.	ETA		Thread Size [mm]	Length [mm]	Head Size [mm]	Max t _{fix} [mm]	Box Quantity	Carton Quantity	List Price per Box
	1	2							
DFM1110010			M6 x 40		10	2	100	800	£12.38
DFM1110000	•		M6 x 55		10	5	100	800	£12.86
DFM1110020	•		M6 x 60		10	10	100	800	£13.69
DFM1110040	•		M6 x 85		10	35	100	400	£15.24
DFM1110050			M8 x 50		13	5	100	400	£17.62
DFM1110060		•	M8 x 60		13	5	100	400	£19.85
DFM1110080		•	M8 x 65		13	10	100	400	£20.27
DFM1110100		•	M8 x 75		13	20	100	400	£21.46
DFM1110120		•	M8 x 85		13	30	100	400	£23.84
DFM1110140		•	M8 x 95		13	40	100	400	£25.31
DFM1110160		•	M8 x 105		13	50	100	400	£28.88
DFM1110180		•	M8 x 130		13	75	50	200	£22.05
DFM1110200		•	M8 x 155		13	100	50	200	£17.10
DFM1110220		•	M8 x 205		13	150	50	200	£32.11
DFM1110230			M10 x 60		17	5	50	200	£15.48
DFM1110260		•	M10 x 85		17	5	50	200	£16.66
DFM1110280		•	M10 x 90		17	10	50	200	£17.33
DFM1110320		•	M10 x 100		17	20	50	200	£18.31
DFM1110340		•	M10 x 110		17	30	50	200	£19.29
DFM1110360		•	M10 x 120		17	40	50	200	£20.16
DFM1110400		•	M10 x 130		17	50	50	200	£31.50
DFM1110440		•	M10 x 160		17	80	50	200	£42.00
DFM1110460		•	M10 x 180		17	100	25	100	£15.50
DFM1110480		•	M10 x 220		17	140	25	100	£21.00
DFM1110520		•	M12 x 90		19	5	50	200	£25.18
DFM1110540		•	M12 x 95		19	10	50	200	£25.71
DFM1110560		•	M12 x 100		19	15	50	200	£32.55
DFM1110580		•	M12 x 105		19	20	25	100	£13.82
DFM1110600		•	M12 x 115		19	30	25	100	£14.77
DFM1110620		•	M12 x 120		19	35	25	100	£15.43
DFM1110640		•	M12 x 135		19	50	25	100	£19.95
DFM1110660		•	M12 x 165		19	80	25	100	£18.01
DFM1110680		•	M12 x 175		19	90	25	100	£18.53
DFM1110700		•	M12 x 185		19	100	25	100	£20.07
DFM1110720		•	M12 x 220		19	135	10	40	£10.33
DFM1110740		•	M16 x 115		24	5	25	100	£26.57
DFM1110760		•	M16 x 125		24	15	20	80	£22.12
DFM1110780		•	M16 x 135		24	25	20	80	£22.74
DFM1110800		•	M16 x 150		24	40	20	80	£25.59
DFM1110810		•	M16 x 160		24	50	10	40	£12.96
DFM1110830		•	M16 x 210		24	100	10	40	£16.15
DFM1110870			M20 x 125		30	5	10	40	£22.62
DFM1110880		•	M20 x 160		30	5	10	40	£26.19
DFM1110900		•	M20 x 170		30	15	10	40	£27.38
DFM1110920		•	M20 x 175		30	20	10	40	£28.57
DFM1110940		•	M20 x 185		30	30	10	40	£32.14
DFM1110960		•	M20 x 200		30	45	10	40	£35.71
DFM1110980		•	M20 x 215		30	60	10	40	£38.10
DFM1110070		•	EN ISO 7093 (DIN 9021) Washer Only M8				100	800	£4.76
DFM1110250		•	EN ISO 7093 (DIN 9021) Washer Only M10				100	800	£6.13
DFM1110510		•	EN ISO 7093 (DIN 9021) Washer Only M12				100	800	£10.64
DFM1110730		•	EN ISO 7093 (DIN 9021) Washer Only M16				100	800	£19.74

PTB UNIVERSAL HEAVY DUTY THROUGHBOLTS

APPLICATIONS

- Steel constructions
- Safety barriers
- Ventilation systems & air conditioning
- Machines
- Fire escapes
- Gates
- Façades
- Approved for outside use

MATERIALS









See page 15 for details.

APPROVALS



PTB-SS-ETA1-PRO - STAINLESS STEEL



Cat No.								List Price per Box
Cat No.		Thread Size [mm]	Length [mm]	Head Size [mm]	Max t_{fix} [mm]	Box Quantity	Carton Quantity	
DFM1 140000		M6 x 55		10	5	200	800	-
DFM1 140020		M6 x 85		10	30	200	800	-
DFM1 140050		M8 x 50		13	5	200	800	-
DFM1 140190	•	M8 x 65		13	10	100	400	-
DFM1 140200	•	M8 x 75		13	20	100	400	-
DFM1 140220	•	M8 x 85		13	30	100	400	-
DFM1 140250	•	M8 x 95		13	40	100	400	-
DFM1 140270	•	M8 x 105		13	50	100	400	-
DFM1 140300	•	M8 x 120		13	65	50	200	-
DFM1 140310	•	M8 x 130		13	75	50	200	-
DFM1 140350		M10 x 60		17	5	100	400	-
DFM1 140360	•	M10 x 80		17	1	50	200	-
DFM1 140400	•	M10 x 85		17	5	50	200	-
DFM1 140430	•	M10 x 90		17	10	50	200	-
DFM1 140450	•	M10 x 100		17	20	50	200	-
DFM1 140480	•	M10 x 110		17	30	50	200	-
DFM1 140500	•	M10 x 130		17	50	50	200	-
DFM1 140530	•	M10 x 160		17	80	50	200	-
DFM1 140550	•	M10 x 180		17	100	25	100	-
DFM1 140600		M12 x 80		17	10	50	200	-
DFM1 140700	•	M12 x 100		19	15	50	200	-
DFM1 140750	•	M12 x 125		19	40	25	100	-
DFM1 140800	•	M12 x 135		19	50	25	100	-
DFM1 140850		M16 x 100		24	5	25	100	-
DFM1 140870	•	M16 x 125		24	15	20	80	-
DFM1 140900	•	M16 x 150		24	40	20	80	-
DFM1 140930		M20 x 120		30	5	10	40	-
DFM1 140950		M20 x 160		30	25	10	40	-

PTB UNIVERSAL HEAVY DUTY THROUGHBOLTS

APPLICATIONS

- Piping & heating supports
- Heating pumps
- Ventilation systems & air conditioning
- Safety barriers
- Fire escapes
- Railings
- Suitable for applications where there is a demand for higher corrosion resistance

MATERIALS









See page 15 for details.

APPROVALS

PTB-G - HOT DIPPED GALVANIZED



Cat No.	 Thread Size [mm]	 Length [mm]	 Head Size [mm]	 Max f_{fix} [mm]	 Box Quantity	 Carton Quantity	List Price per Box
DFM1150050	M8 x 50		13	5	100	800	£46.68
DFM1150080	M8 x 65		13	10	100	400	£47.85
DFM1150120	M8 x 85		13	30	100	400	£48.76
DFM1150160	M8 x 105		13	50	100	400	£49.84
DFM1150230	M10 x 60		17	5	100	400	£57.35
DFM1150280	M10 x 90		17	10	50	200	£31.10
DFM1150320	M10 x 100		17	20	50	200	£32.68
DFM1150360	M10 x 120		17	40	50	200	£37.80
DFM1150440	M10 x 160		17	80	50	200	£40.78
DFM1150250	M12 x 80		19	5	50	200	£42.23
DFM1150580	M12 x 105		19	20	25	100	£22.56
DFM1150620	M12 x 120		19	35	25	100	£25.34
DFM1150640	M12 x 135		19	50	25	100	£28.38
DFM1150660	M12 x 165		19	80	25	100	£30.89
DFM1150680	M12 x 175		19	90	25	100	£34.73
DFM1150730	M16 x 100		24	5	25	100	£72.80
DFM1150780	M16 x 135		24	25	20	80	£58.73
DFM1150810	M16 x 160		24	50	10	40	£33.70
DFM1150830	M16 x 210		24	100	10	40	£46.76
DFM1150860	M20 x 120		30	5	10	40	£49.16
DFM1150850	M20 x 170		30	35	10	40	£56.23

FHS FIXED HEAD SLEEVE ANCHORS

DESCRIPTION

- Light sleeve anchor for push-through installation
- Steel quality of 4.8 grade
- Available from 45-100mm length

APPLICATIONS

- Piping & heating supports
- Steel beams
- Timber framing
- Heavy duty doors and security shutters



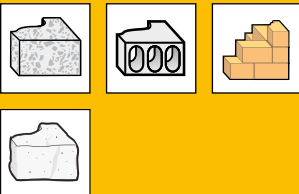



MATERIALS



See page 15 for details.

ZINC PLATED



Cat No.	 Drill Dia. [mm]	 Length [mm]	 Head Size [mm]	 Thread Size [mm]	 Max f_{fix} [mm]	 Box Quantity	 Carton Quantity	List Price per Box
DFM1210390	8 x 45		10	6	1	100	800	£22.38
DFM1210450	10 x 55		13	8	5	50	400	£18.45
DFM1210480	10 x 80		13	8	30	50	400	£23.21
DFM1210510	10 x 100		13	8	50	25	200	£13.99
DFM1210540	12 x 65		16	10	5	25	200	£14.88
DFM1210570	12 x 80		16	10	20	25	200	£15.48

SHIELD ANCHORS

DESCRIPTION

- Zinc plated shield expansion anchors available with projecting bolt, hex head and shield only
- For use in soft, existing and non-homogeneous base materials
- Bolt or threaded rod is removable

APPLICATIONS

- Lattice work
- Steel rails and gates
- Signs
- Aerials
- Pipe work
- Fencing



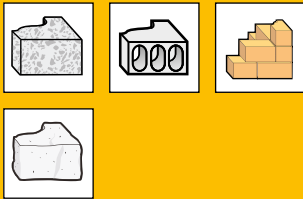



MATERIALS

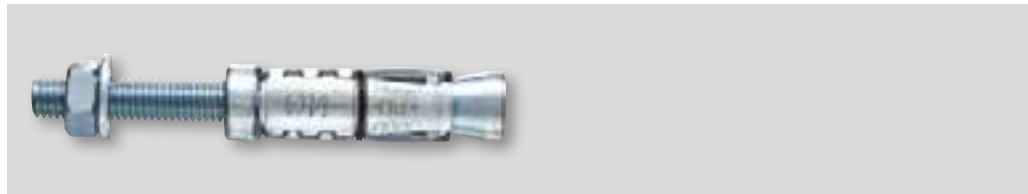

See page 15 for details.







SAP PROJECTING BOLT - ZINC PLATED

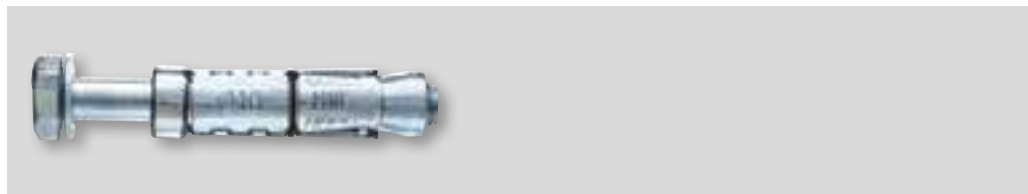

Cat No.	 Drill Dia. [mm]	 Thread Size [mm]	 Length [mm]	 Head Size [mm]	 Box Quantity	 Carton Quantity	List Price per Box
DFM2450120		12 x M6 x 70		10	50	400	£20.00
DFM2450140		12 x M6 x 95		10	50	400	£23.21
DFM2450160		14 x M8 x 65		13	50	400	£28.57
DFM2450180		14 x M8 x 90		13	50	200	£30.95
DFM2450200		14 x M8 x 130		13	25	100	£17.56
DFM2450220		16 x M10 x 80		17	50	200	£47.62
DFM2450240		16 x M10 x 90		17	50	200	£48.81
DFM2450260		16 x M10 x 110		17	25	100	£25.60
DFM2450280		16 x M10 x 130		17	25	100	£26.79
DFM2450300		20 x M12 x 90		19	25	100	£34.50
DFM2450320		20 x M12 x 100		19	25	100	£36.01
DFM2450340		20 x M12 x 125		19	10	40	£17.42
DFM2450360		20 x M12 x 145		19	10	40	£19.01

SAL HEX HEAD LOOSE BOLT - ZINC PLATED



Cat No.	 Drill Dia. [mm]	 Thread Size [mm]	 Length [mm]	 Head Size [mm]	 Box Quantity	 Carton Quantity	List Price per Box
DFM2450400		12 x M6 x 55		10	50	400	£19.29
DFM2450420		12 x M6 x 70		10	50	400	£20.24
DFM2450440		12 x M6 x 85		10	50	400	£21.67
DFM2450460		14 x M8 x 60		13	50	400	£27.38
DFM2450480		14 x M8 x 75		13	50	200	£28.57
DFM2450500		14 x M8 x 90		13	50	200	£30.95
DFM2450520		16 x M10 x 80		17	50	200	£38.10
DFM2450540		16 x M10 x 85		17	50	200	£41.67
DFM2450560		16 x M10 x 110		17	50	200	£50.60
DFM2450580		16 x M10 x 135		17	25	100	£27.98
DFM2450600		20 x M12 x 85		19	25	100	£34.52
DFM2450620		20 x M12 x 90		19	25	100	£35.71
DFM2450640		20 x M12 x 115		19	25	100	£37.50
DFM2450660		20 x M12 x 135		19	25	100	£38.69

SHIELD ANCHORS

DESCRIPTION

- Zinc plated shield expansion anchors available with projecting bolt, hex head and shield only
- For use in soft, existing and non-homogeneous base materials
- Bolt or threaded rod is removable

APPLICATIONS

- Lattice work
- Steel rails and gates
- Signs
- Aerials
- Pipe work
- Fencing



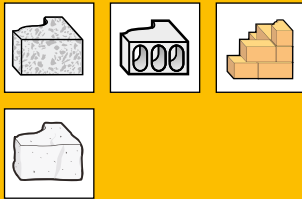

MATERIALS

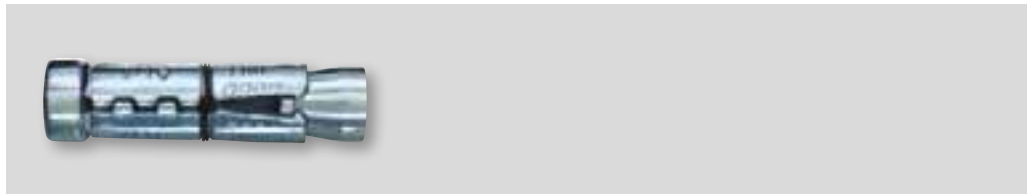

See page 15 for details.

SA SHIELD ONLY - ZINC PLATED



Cat No.	 Drill Dia. [mm]	 Thread Size [mm]	 Length [mm]	 Box Quantity	 Carton Quantity	List Price per Box
DFM2450000		12 x M6 x 45		50	400	£22.05
DFM2450020		14 x M8 x 50		50	400	£30.45
DFM2450040		16 x M10 x 60		50	200	£43.05
DFM2450060		20 x M12 x 75		25	200	£26.68

TW TIE WIRE HANGERS

DESCRIPTION

- Universal medium duty anchor with eye

APPLICATIONS

- Suspended ceilings
- Hanging ventilation & ducting





MATERIALS



See page 15 for details.

ZINC PLATED



Cat No.	 Drill Dia. [mm]	 Length [mm]	 Eye Diameter [mm]	 Box Quantity	 Carton Quantity	List Price per Box
DFM1210600		6 x 55	6	100	1600	£12.26

SNAKE INTERNAL THREAD SELF-TAPPING ANCHORS

DESCRIPTION

- Patented, internally threaded self-tapping anchor with ETA option 1 approval for cracked and uncracked concrete
- Approved for very small edge distances
- Complete grip over total anchor length
- Up to 6 times faster installation in comparison with drop-in anchors
- Each box comes with a proprietary bit and setting tool

APPLICATIONS

- Suspending conduit
- Cable trays
- Pipe supports
- Fire sprinklers
- Suspended lighting

MATERIALS

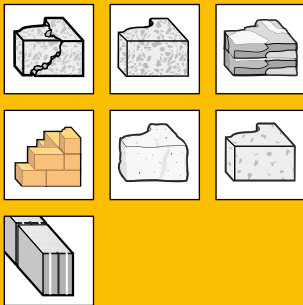

See page 15 for details.

APPROVALS



*M10 Only

SNAKE ANCHOR KIT - ZINC PLATED

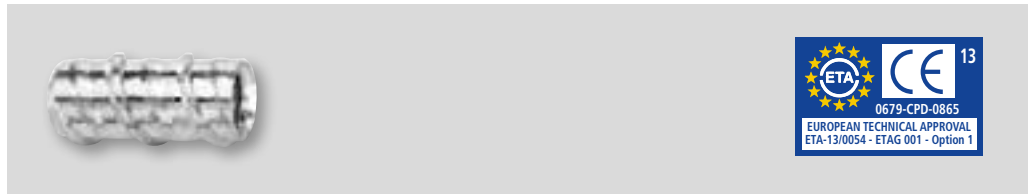

Cat No.		Thread Size [mm]	Length [mm]	Drill Dia. [mm]	Box Quantity	Carton Quantity	List Price per Box
DFM2310050	•	M8 x 31		12.7	50	400	£29.17
DFM2310000	•	M10 x 31		12.7	50	400	£29.23
DFM2310100		M12 x 42		19.1	50	200	£67.38

SNAKE SETTING TOOL

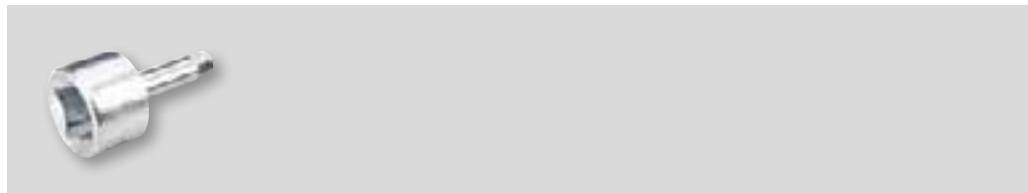

Cat No		Thread Size [mm]	Driver Size	Box Quantity	List Price per Box
DFM2300000		M8	½"	1	£3.06
DFM2300050		M10	½"	1	£3.21
DFM2300100		M12	½"	1	£5.24

DM DROP-IN ANCHORS

DESCRIPTION

- Zinc plated internally threaded expansion anchor
- Easy to install anchor with ETA Option 7 approval for uncracked concrete and part 6 approval for cracked concrete
- F120 fire resistance
- DM-PRO (version without lip) is designed for invisible coverage with mortar after use.

APPLICATIONS

- Electrical fittings & conduit
- Ventilation
- Air conditioning systems
- Suspended ceilings
- Seating
- Barriers & rails

MATERIALS



See page 15 for details.

APPROVALS



*M8 - M12 only

DM-LIP-PRO - ZINC PLATED



Cat No.	ETA		Thread Size [mm]	Length [mm]	Drill Dia. [mm]	Box Quantity	Carton Quantity	List Price per Box
	1	2						
DFM2110000	•		M6 x 25		8	100	1600	£9.52
DFM211010S	•	•	M8 x 30		10	50	800	£8.97
DFM2110100	•	•	M8 x 30		10	100	800	£14.95
DFM211015S	•	•	M10 x 40		12	50	800	£9.43
DFM2110150	•	•	M10 x 40		12	100	800	£15.71
DFM211020S	•	•	M12 x 50		16	50	400	£21.79
DFM2110200	•	•	M12 x 50		16	100	400	£36.31
DFM2110300		•	M16 x 65		20	25	100	£18.93
DFM2110250			M20 x 80		25	25	100	£33.04

DM-PRO - ZINC PLATED



Cat No.	ETA		Thread Size [mm]	Length [mm]	Drill Dia. [mm]	Box Quantity	Carton Quantity	List Price per Box
	1	2						
DFM2110500	•		M6 x 25		8	100	1600	£5.48
DFM211055S	•	•	M8 x 30		10	50	800	£4.57
DFM2110550	•	•	M8 x 30		10	100	800	£7.62
DFM211060S	•	•	M10 x 40		12	50	800	£7.29
DFM2110600	•	•	M10 x 40		12	100	800	£12.14
DFM211065S	•	•	M12 x 50		16	50	400	£14.58
DFM2110650	•	•	M12 x 50		16	100	400	£24.29
DFM2110700		•	M16 x 65		20	25	100	£12.68
DFM2110750			M20 x 80		25	25	100	£25.20

DM DROP-IN ANCHORS

DESCRIPTION

- Internally threaded expansion anchor
- Easy to install anchor with ETA Option 7 approval for uncracked concrete and part 6 approval for cracked concrete (zinc plated & stainless steel only)
- F120 fire resistance
- Approved for applications where there is a demand for higher corrosion resistance

APPLICATIONS

- Electrical fittings & conduit
- Ventilation
- Air conditioning systems
- Suspended ceilings
- Seating
- Barriers & rails

MATERIALS



See page 15 for details.

APPROVALS



*M8 - M12 only

DM-SS-PRO - A4 STAINLESS STEEL



Cat No.	ETA		Thread Size [mm]	Length [mm]	Drill Dia. [mm]	Box Quantity	Carton Quantity	List Price per Box
	1	2						
DFM2120000	•		M6 x 25		8	100	1600	£45.24
DFM2120050	•	•	M8 x 30		10	100	800	£66.67
DFM2120100	•	•	M10 x 40		12	100	800	£114.29
DFM2120150	•	•	M12 x 50		16	100	400	£242.86
DFM2120200		•	M16 x 65		20	25	100	£116.07
DFM2120250			M20 x 80		25	25	100	£232.14

SETTING TOOLS



Cat No.	Thread Size [mm]	Box Quantity	Carton Quantity	List Price per Box
DFM2100010	M6	1	-	£1.43
DFM2100060	M8	1	-	£1.47
DFM2100110	M10	1	-	£1.93
DFM2100160	M12	1	-	£2.93
DFM2100210	M16	1	-	£3.44
DFM2100260	M20	1	-	£4.73

SETTING TOOLS WITH SAFETY GRIP

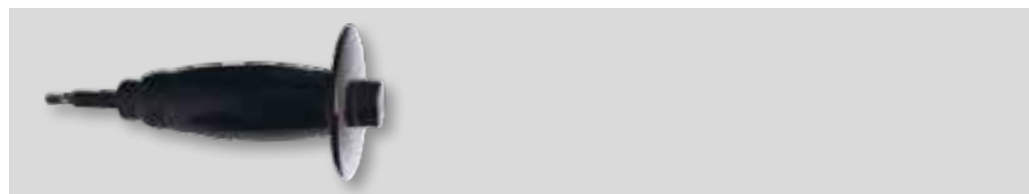

Cat No.	Thread Size [mm]	Box Quantity	Carton Quantity	List Price per Box
DFM2100000	M6	1	-	£13.16
DFM2100050	M8	1	-	£13.94
DFM2100100	M10	1	-	£15.49
DFM2100150	M12	1	-	£17.81
DFM2100200	M16	1	-	£20.13
DFM2100250	M20	1	-	£21.68

VERTIGO™ CONCRETE HANGERS

DESCRIPTION

- All steel self-tapping threaded fastening system
- For suspending steel threaded rod vertically overhead

APPLICATIONS

- Hanging pipes
- Sprinkler systems
- Lighting systems
- Suspended ceilings

MATERIALS

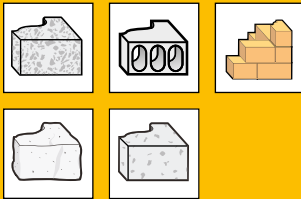

See page 15 for details.

VERTIGO™ CONCRETE HANGER - ZINC PLATED



Cat No.	Thread Size [mm]	Length [mm]	Length [mm]	Drill Dia. [mm]	Head Size [mm]	Box Quantity	Carton Quantity	List Price per Box
DFM2220000	6 x 32	12	6.5	10	100	800	£33.33	
DFM2220050	8 x 39	16	6.5	13	50	400	£17.86	
DFM2220100	10 x 39	16	6.5	13	50	400	£19.05	

VERTIGO™ INSTALLATION TOOL

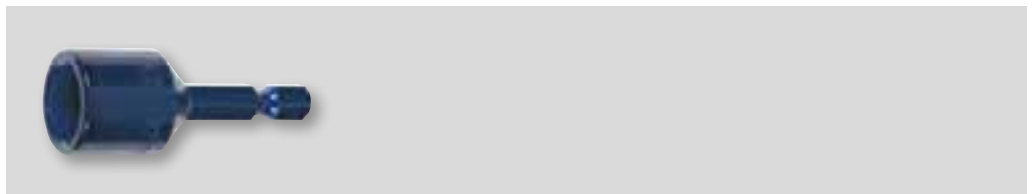

Cat No.	Thread Size [mm]	Box Quantity	List Price per Box
DFM2200050	M6	5	£16.57
DFM2200100	M8 – M10	5	£18.72

TAPPER-PRO SCREWS

DESCRIPTION

- One-piece self-tapping concrete screw for use in a variety of base materials including wood
- Features a corrosion resistant Perma-Seal® coating and an optimised thread design for lower installation torque. The screw also incorporates a gimlet drill point for wood (no pre-drilling required)
- The only concrete screw to meet the 2012 IBC and IRC standards for 4 different base materials

APPLICATIONS

- Screen enclosures
- Exterior metal lighting
- Storm shutters
- Marine applications

MATERIALS



See page 15 for details.

APPROVALS



TAPPER-PRO HEX HEAD SCREWS - PERMA-SEAL®

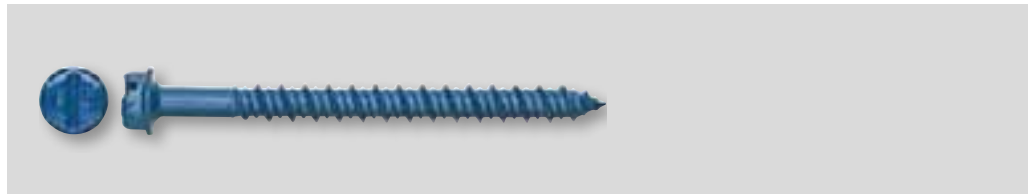

Cat No.	Thread Size [mm]	Length [mm]	Drill Dia. [mm]	Max f_{fix} [mm]	Box Quantity	Carton Quantity	List Price per Box
DWT1400100	6.3 x 32		4.8*	7**	100	1600	£9.13
DWT1400150	6.3 x 45		4.8*	1	100	1600	£9.49
DWT1400200	6.3 x 57		4.8*	13	100	800	£9.76
DWT1400250	6.3 x 70		4.8*	26	100	800	£11.12
DWT1400300	6.3 x 82		4.8*	38	100	400	£14.29

*Please refer to the Technical Manual and ICC-ES for correct installation instructions

**Reduced embedment depth of 25mm, not suitable for ICC-ES approval

TAPPER-PRO FLAT HEAD SCREWS - PERMA-SEAL®

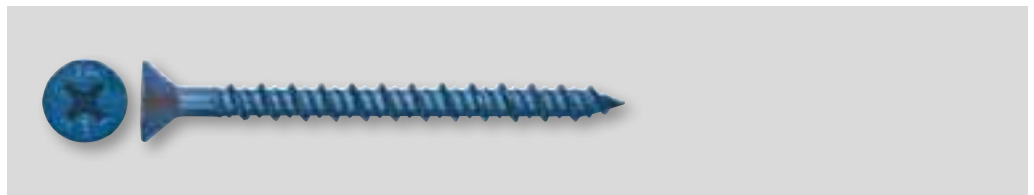

Cat No.	Thread Size [mm]	Length [mm]	Drill Dia. [mm]	Max f_{fix} [mm]	Box Quantity	Carton Quantity	List Price per Box
DWT1410650	4.8 x 57		4*	13	100	800	£9.13
DWT1410700	4.8 x 70		4*	26	100	800	£9.49
DWT1410850	4.8 x 101		4*	57	100	800	£9.76
DWT1410100	6.3 x 32		4.8*	7**	100	1600	£11.12
DWT1410150	6.3 x 45		4.8*	1	100	1600	£14.29
DWT1410200	6.3 x 57		4.8*	13	100	800	£16.19
DWT1410250	6.3 x 70		4.8*	26	100	800	£20.98
DWT1410300	6.3 x 82		4.8*	38	100	400	£6.14
DWT1410400	6.3 x 101		4.8*	57	100	400	£7.14
DWT1410450	6.3 x 127		4.8*	83	100	400	£9.04

*Please refer to the Technical Manual and ICC-ES for correct installation instructions

**Reduced embedment depth of 25mm, not suitable for ICC-ES approval

TAPPER-PRO SCREWS

DESCRIPTION

- Tapper-Pro drill bits for use with Tapper-Pro screws, designed with the specific tolerance for proper installation.

APPLICATIONS

- Screen enclosures
- Exterior metal lighting
- Storm shutters
- Marine applications

MATERIALS

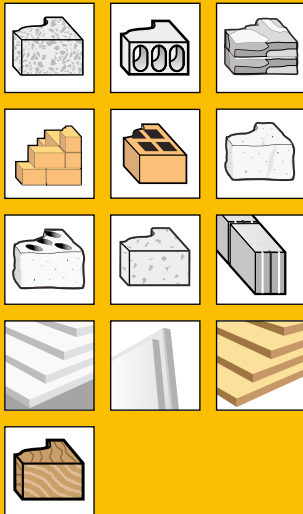

See page 15 for details.

APPROVALS



TAPPER-PRO SS DRILL BITS*

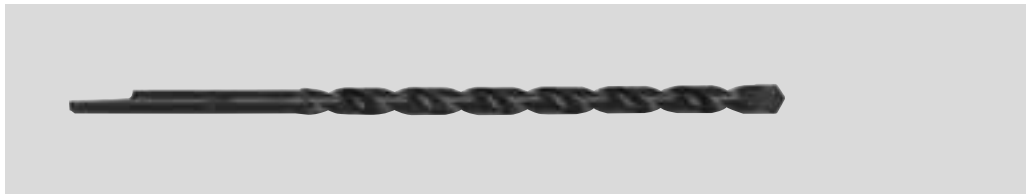

Cat No.	Length [mm]	Drill Dia. [mm]	Box Quantity	Carton Quantity	List Price per Box
DPA2110000	89	4	10	-	-
DPA2110050	114	4	10	-	-
DPA2110100	140	4	10	-	-
DPA2110150	89	4.8	10	-	-
DPA2110200	114	4.8	10	-	-
DPA2110250	140	4.8	10	-	-
DPA2110300	165	4.8	10	-	-
DPA2110350	190	4.8	10	-	-

*Tapper-Pro require the use of specific tolerance Tapper-Pro drill bits for proper installation.

SPIKE® MUSHROOM HEAD SPIKES

DESCRIPTION

- Patented, one-piece, tamper-proof vibration resistant anchor in 8.2 grade steel with mushroom head
- Pre-expanded anchor design allows for easy installation

APPLICATIONS

- Railings
- Lattice work
- Street furniture
- Metal track attachments
- Cable trays and struts

MATERIALS

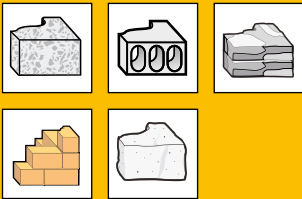

See page 15 for details.

ZINC PLATED

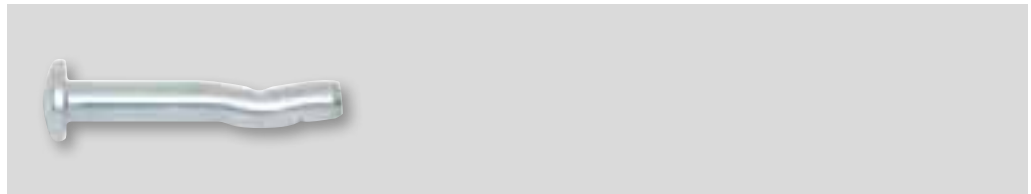

Cat No.	Drill Dia. [mm]	Length [mm]	Max t _{fix} [mm]	Box Quantity	Carton Quantity	List Price per Box
DFM3110240	5	32	10	100	1600	£10.36
DFM3110280	5	38	16	100	1600	£10.71

SPIKE® TIE WIRE SPIKE

DESCRIPTION

- Patented, one-piece, vibration resistant anchor in 8.2 grade steel with eye
- Pre-expanded anchor design allows for easy installation

APPLICATIONS

- Suspended ceilings
- Wire hangers

MATERIALS

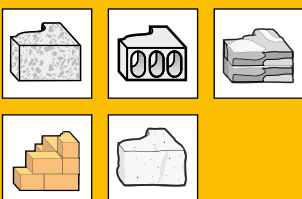

See page 15 for details.

ZINC PLATED



Cat No.	Drill Dia. [mm]	Length [mm]	Eye Diameter [mm]	Box Quantity	Carton Quantity	List Price per Box
DFM3110000	5	30	6	100	1600	£22.61

PBZ STEEL WEDGE NAILS

DESCRIPTION

- Steel wedge nail with ETA part 6 approval for redundant systems
- F120 fire resistance approved
- Hammer set anchor for push through installation
- The simpler BSC-PBZ-PRO provides a more cost-effective anchor

APPLICATIONS

- Battens
- Metal profiles
- Suspended ceiling brackets
- Angle brackets

MATERIALS

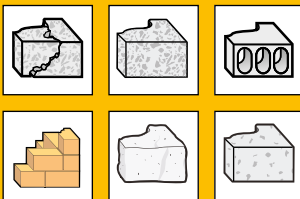

See page 15 for details.

APPROVALS



BSC-PBZ-PRO

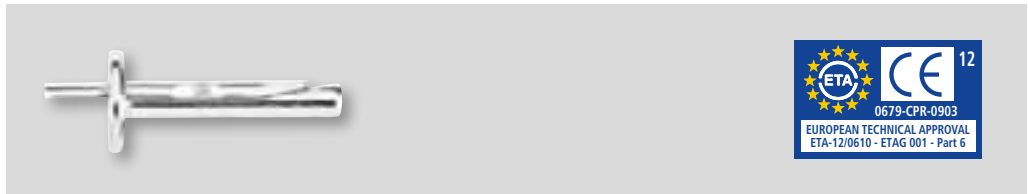

Cat No.		Drill Dia. [mm]	Length [mm]	Max t _{fix} [mm]	Box Quantity	Carton Quantity	List Price per Box
DFM3310000	•	6 x 35	5	5	200	1600	£14.29
DFM3310050	•	6 x 65	35	35	100	800	£11.90

PBZ-PRO

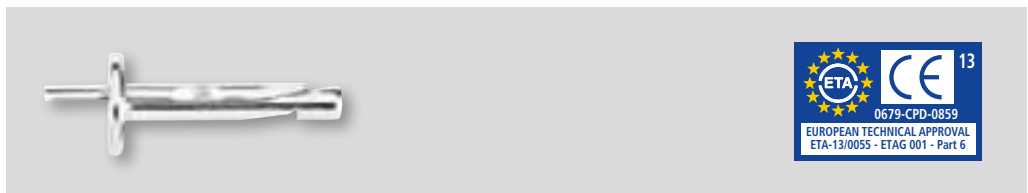

Cat No.		Drill Dia. [mm]	Length [mm]	Max t _{fix} [mm]	Box Quantity	Carton Quantity	List Price per Box
DFM3310100	•	6 x 35	5	5	100	800	£11.90
DFM3310150	•	6 x 65	35	35	100	400	£16.67

EXPRESS NAIL CEILING CLIPS

DESCRIPTION

- Express nail with eye for lighter applications in concrete and masonry
- The nail sleeve is hammered in and expands its entire length in the hole

APPLICATIONS

- Lightweight suspended ceilings
- Wire hangers

MATERIALS

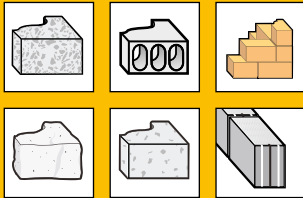

See page 15 for details.

ZINC PLATED

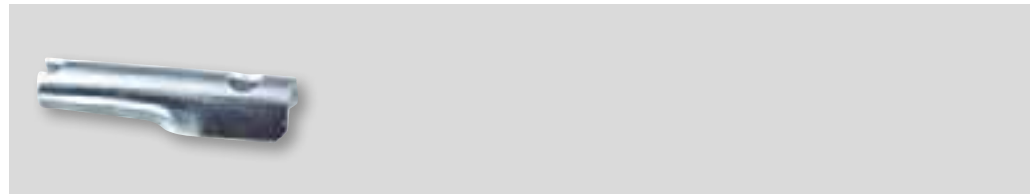

Cat No.	Drill Dia. [mm]	Length [mm]	Eye Diameter [mm]	Box Quantity	Carton Quantity	List Price per Box
DFM3130500	8	42	5	100	800	£9.86

EXPRESS NAIL FIXINGS

DESCRIPTION

- Express nail for lighter applications in concrete and masonry
- The nail sleeve is hammered in and expands its entire length in the hole
- The collar holds the item to be attached

APPLICATIONS

- Temporary or non-structural fixings
- Scaffolding
- Temporary railings

MATERIALS

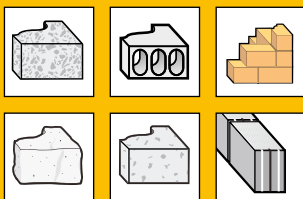

See page 15 for details.

ZINC PLATED

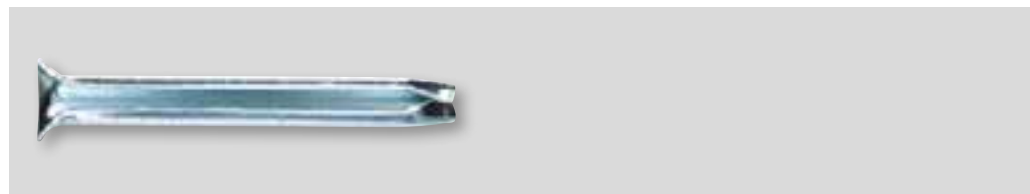

Cat No.	Drill Dia. [mm]	Length [mm]	Head Size [mm]	Max fix [mm]	Box Quantity	Carton Quantity	List Price per Box
DFM3130000	6	30	12	2	200	1600	£10.50
DFM3130050	6	40	12	10	200	1600	£11.55
DFM3130100	6	50	12	20	200	800	£11.90
DFM3130150	6	60	12	30	200	800	£12.86
DFM3130200	6	80	12	50	100	800	£8.10
DFM3130250	8	70	14	30	100	400	£9.52
DFM3130300	8	90	14	50	100	400	£12.14
DFM3130350	8	110	14	50	50	200	£7.26
DFM3130400	8	130	14	70	50	200	£8.69
DFM3130450	8	150	14	90	100	400	£19.05

ISO METAL INSULATION FIXINGS

DESCRIPTION

- One piece metal insulation fixing
- Time saving design using simple hammer set installation
- Can be used as part of a fire-resistance application

APPLICATIONS



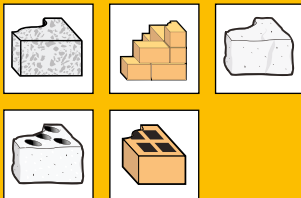

- For fixing insulation materials beneath cladding / facade panels where non-flammable materials are specified

MATERIALS



See page 15 for details.



Cat No.	 Drill Dia. [mm]	 Length [mm]	 Head Dia. [mm]	 Box Quantity	 Carton Quantity	List Price per Box
DFM3150000	8 x 90	35	50	50	100	£9.05
DFM3150050	8 x 110	35	50	50	100	£12.83
DFM3150100	8 x 140	35	50	50	100	£13.33
DFM3150150	8 x 170	35	50	50	100	£13.79

PRO NYLON HAMMER SCREWS

DESCRIPTION

- Nylon anchors for fixing external thermal insulation composite systems with rendering
- Nail stopper prevents expansion before nylon part is fully embedded
- Polyamide material PA6 for maximum performance, also in cold environments

APPLICATIONS

- Thermal insulation supports
- Conduit clips
- Skirting boards
- Metal brackets and frames
- Trunking

MATERIALS

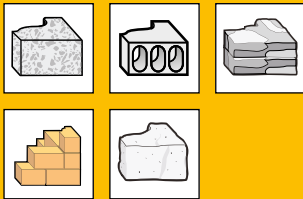

See page 15 for details.

APPROVALS



NHS-PRO HAMMER SCREW - NYLON



Cat No.	ETA	Drill Dia. [mm]	Length [mm]	Max t_{fix} [mm]	Box Quantity	Carton Quantity	List Price per Box
DFM3420000	•	5 x 27		2	200	1600	£9.70
DFM3420100	•	6 x 40		10	200	800	£10.95
DFM3420150	•	6 x 55		25	100	800	£7.14
DFM3420250	•	6 x 80		50	100	400	£9.74
DFM3420300	•	8 x 60		20	100	400	£12.62
DFM3420350	•	8 x 75		35	100	400	£14.29
DFM3420400	•	8 x 100		60	100	400	£19.05

NHS-F-PRO COLLARED HAMMER SCREW - NYLON



Cat No.	ETA	Drill Dia. [mm]	Length [mm]	Max t_{fix} [mm]	Box Quantity	Carton Quantity	List Price per Box
DFM3210250	•	5 x 25		1	200	1600	£8.67
DFM3210450	•	6 x 40		10	200	800	£18.00

NYLON HAMMER SCREWS

DESCRIPTION

- Basic nylon hammer screw
- Easy to install through part to be fixed
- Expands by hammering or screwing (can be removed)

APPLICATIONS

- Thermal insulation supports
- Trunking
- Conduit clips
- Skirting boards
- Metal brackets and frames

MATERIALS

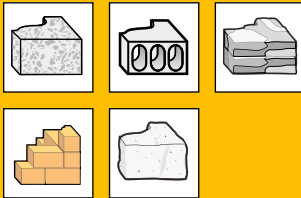

See page 15 for details.

BSC-NHS HAMMER SCREW - NYLON



Cat No.	Drill Dia. [mm]	Length [mm]	Max t _{fix} [mm]	Box Quantity	Carton Quantity	List Price per Box
DFM3210000	6 x 35	10	100	800	£4.02	
DFM321005S	6 x 60	35	50	800	£3.49	
DFM3210050	6 x 60	35	100	800	£5.81	
DFM321006S	6 x 80	45	50	400	£3.89	
DFM321007S	8 x 60	20	50	400	£5.75	
DFM321010S	8 x 80	40	50	400	£6.31	
DFM3210100	8 x 80	40	80	640	£8.42	
DFM321015S	8 x 100	60	50	200	£7.66	
DFM3210150	8 x 100	60	100	200	£12.76	
DFM321018S	8 x 120	80	50	200	£8.50	

BSC-NHSF COLLARED HAMMER SCREW - NYLON



Cat No.	Drill Dia. [mm]	Length [mm]	Max t _{fix} [mm]	Box Quantity	Carton Quantity	List Price per Box
DFM3210200	6 x 40	10	100	800	£3.33	

MFA METAL FRAME ANCHORS

DESCRIPTION

- Metal frame expansion anchor
- By turning the metric screw the cone is drawn into the sleeve and the fixing is expanded
- Suitable for fixture thicknesses of 42-102mm





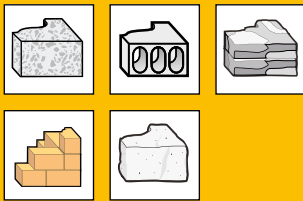

APPLICATIONS

- Wood, plastic or aluminium door frames and window frames

MATERIALS



See page 15 for details.

Cat No.	 Drill Dia. [mm]	 Length [mm]	 Max f_{fix} [mm]	 Box Quantity	 Carton Quantity	List Price per Box
DFM3510000	10 x 72		42	50	400	£6.62
DFM3510050	10 x 92		62	50	400	£7.49
DFM3510100	10 x 112		82	50	400	£8.46
DFM3510150	10 x 132		102	25	200	£4.83

WINDOW SCREWS

DESCRIPTION

- Window screw with cylindrical head for wooden frames and with flat head for metal and plastic frames
- Zinc plated with either a T25 or T30 torx recess and self-tapping thread
- Stress-free fastening without additional plugs
- Only requires 6mm drill diameter (6.5mm in extra hard brick or concrete)

APPLICATIONS

- Wooden and plastic window frames

MATERIALS



See page 15 for details.

PSZ - FOR WOODEN FRAMES

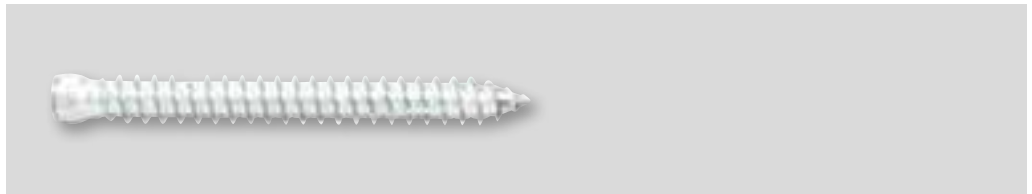

Cat No.	Thread Size [mm]	Length [mm]	TORX [mm]	Max t _{fix} [mm]	Box Quantity	Carton Quantity	List Price per Box
DFM3520350	7.5 x 72		T25	42	100	400	£7.14
DFM3520400	7.5 x 92		T25	62	100	400	£9.52
DFM3520450	7.5 x 112		T25	82	50	200	£6.55
DFM3520500	7.5 x 132		T25	102	50	200	£8.33
DFM3520550	7.5 x 152		T25	122	50	200	£10.12
DFM3520650	7.5 x 182		T25	152	50	200	£17.26

PS - FOR PLASTIC FRAMES

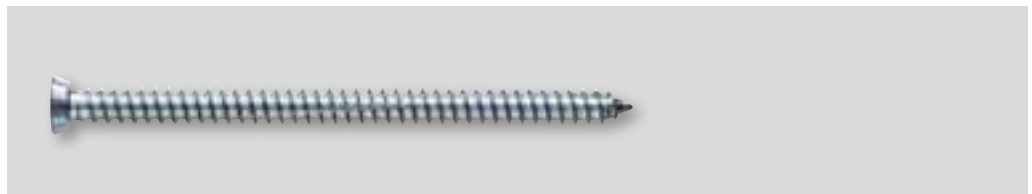

Cat No.	Thread Size [mm]	Length [mm]	TORX [mm]	Max t _{fix} [mm]	Box Quantity	Carton Quantity	List Price per Box
DFM3510250	7.5 x 72		T30	42	100	400	£7.14
DFM3510300	7.5 x 92		T30	62	100	400	£9.52
DFM3510350	7.5 x 112		T30	82	50	200	£6.55
DFM3510400	7.5 x 132		T30	102	50	200	£8.33
DFM3510450	7.5 x 152		T30	122	50	200	£10.12
DFM3510500	7.5 x 182		T30	152	50	200	£17.26

ADHESIVE ANCHORS



ADHESIVE ANCHORS & ACCESSORIES FOR EVERY APPLICATION.

The **DEWALT** adhesive anchors range offers high performance, stress free fixing into brickwork, block work and concrete.

WORKING PRINCIPLES

Best suited for high load applications, the resulting bond between stud and resin is often stronger than the base material itself. The low expansion and splitting forces when the anchor is prestressed or loaded allow small edge distances and spacings.

This makes them ideal for close to edge fixing, close spacing and use in concrete of unknown quality or low compressive strength.

Each **DEWALT** adhesive anchor is specifically formulated to provide a unique set of properties to suit various applications. Load capacities will depend on base material strength and integrity, stud or rebar specification and embedment depths.

For full technical information and to download the relevant approval and certification documentation please visit www.DEWALT.com.

PURE EPOXY ANCHORS



PURE110-PRO and PURE150-PRO

- High thermal and high mechanical loading properties
- Outstanding resistance to chemicals
- Approved for use in both cracked and uncracked concrete
- Suitable for diamond drilled holes
- Suited to wet conditions/water filled holes and poor site conditions

VINYLESTER ANCHORS



AC100-PRO and AC100-NORDIC

- Good thermal and high mechanical loading properties
- Styrene free vinylester anchor
- Faster curing times
- High adhesive resistance, especially in alkaline conditions
- Suited to wet conditions/water filled holes
- Approved for a wide range of base materials

POLYESTER ANCHORS



PV45-PRO and PV50-PRO

- Quick curing
- Suited to a wide range of base materials
- Cost-effective solution
- Low odour formulation (PV45)

TYPICAL SETTING TIMES (AT 10°C)







TYPE	PV45-PRO	PV50-PRO	AC100-PRO	AC100-NORDIC	PURE110-PRO	PURE150-PRO
GEL	15 min	15 min	15 min	6 min	90 min	90 min
DRY	80 min	80 min	80 min	60 min	24 h	30 h
WET	Not suitable	Not suitable	160 min	120 min	48 h	60 h

PURE150-PRO STYRENE FREE PURE EPOXY ADHESIVE ANCHOR

DESCRIPTION

- Pure epoxy mortar with ETA-option 1 approval, for use in cracked and uncracked concrete
- Approved for overhead applications and in dry, wet and water filled holes
- The cracked concrete approval is valid for fixing with normal threaded rods, rebars and an internal threaded sleeve
- Approved for diamond drilled holes
- Approved for seismic loads according to category C1
- Up to 24 month shelf life



Cat No.		 Cartridge Size [ml]	 Box Quantity	 Carton Quantity	List Price per Box
DFC1110000	•	385	1	10	£20.78
DFC1110050	•	585	1	10	£23.80
DFC1110100	•	1400	1	5	£50.23

SETTING TIMES

TEMP °C	GEL	SET DRY	SET WET
+5	2 h	50 h	100 h
+10	90 min	30 h	60 h
+20	30 min	10 h	20 h
+30	20 min	6 h	12 h
+40	12 min	4 h	8 h

MATERIALS

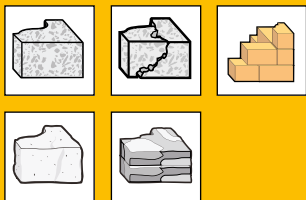



See page 15 for details.

APPROVALS



DISPENSING TOOLS



Cat No.	Type	 Cartridge Size [ml]	 Box Quantity	 Carton Quantity	List Price per Box
DFC1610350	Manual	385/585	1	5	£60.60
DFC1610200	Heavy Duty Manual	385/585	1	10	£160.49
DFC1630050	Pneumatic	385/585	1	-	£714.61
DFC1630500	Pneumatic	1400	1	-	£1,556.76

PURE110-PRO STYRENE FREE PURE EPOXY ADHESIVE ANCHOR

DESCRIPTION

- High strength pure epoxy mortar with ETA-option 1 approval for bonding steel elements to cracked and uncracked concrete
- Approved for overhead applications and in dry, wet and water filled holes
- Consistent high approved loads even at elevated temperature ranges
- Suitable for diamond drilled holes
- Approved for seismic loads according to category C1
- Up to 24 month shelf life



Cat No.	ETA	Cartridge Size [ml]	Box Quantity	Carton Quantity	List Price per Box
DFC1130000	•	265	1	10	£12.38
DFC1130050	•	620	1	10	£19.65

SETTING TIMES

TEMP °C	GEL	SET DRY	SET WET
+5	90 min	72 h	144 h
+10	90 min	24 h	48 h
+20	25 min	8 h	16 h
+30	20 min	8 h	16 h
+40	12 min	4 h	8 h

MATERIALS

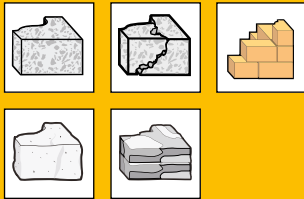

See page 15 for details.

APPROVALS



DISPENSING TOOLS

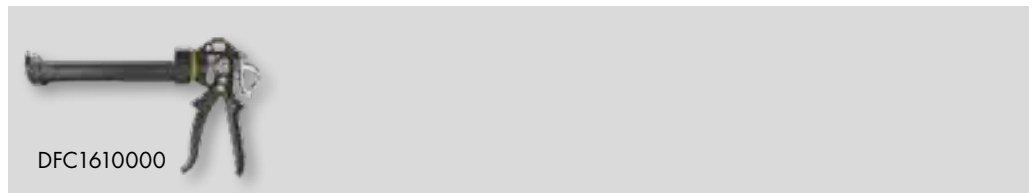

Cat No.	Type	Cartridge Size [ml]	Box Quantity	Carton Quantity	List Price per Box
DFC1610000	Manual	265/300	1	12	£19.05
DFC1610300	Manual	620	1	8	£50.00



AC100-PRO STYRENE FREE VINYLESTER ANCHOR

APPROVED FOR ALMOST ANY APPLICATION.

The AC100-PRO is a two-component vinylester adhesive anchor and is approved for almost all applications and base materials.

It provides consistent performance in uncracked and cracked concrete with a wide range of hole diameters and embedment depths as well as flexible fixture thicknesses and a simple installation process.

FOR CONCRETE

- ETAG 001 approved (ETA Option 1) for use in cracked concrete

FOR MASONRY

- ETAG 029 approved for use in solid and hollow brick

FOR POST-INSTALLED REBAR

- ETA and National German Approval

FOR SEISMIC LOADING

- Seismic loading approval according to category C1.

FLEXIBILITY BUILT-IN.

The AC100-PRO is approved for a short time temperature range of up to 120°C and can even be used in water filled holes. It also provides a fast curing time and high load capacity making it the ideal adhesive anchor for use on-site.

- Approved for water filled drill holes and overhead applications (M8 - M16)
- Installation down to -10°C
- Suitable for use in rotary hammer drilled holes
- Up to 18 month shelf life (up to 12 months for 300ml size)

The system also includes an extensive range of accessories including mixing nozzles, dispensing tools, brushes and threaded rods - see pages 56–59 for more information.

AC100-PRO STYRENE FREE VINYLESTER ANCHOR

MATERIALS

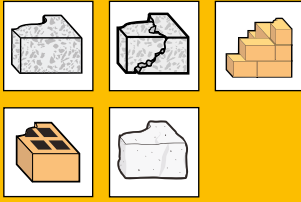

See page 15 for details.

APPROVALS



Cat No.		Cartridge Size [ml]	Box Quantity	Carton Quantity	List Price per Box
DFC1210200	•	150	1	10	£8.39
DFC1230050	•	300	1	10	£12.24
DFC1230100	•	360	1	10	£11.78
DFC1230000	•	410	1	10	£11.91
DFC1230150	•	825	1	8	£27.07

SETTING TIMES

TEMP °C	GEL	SET DRY	SET WET
-10° C	90 min	24 h	48 h
-5° C	90 min	14 h	28 h
0° C	45 min	7 h	14 h
5° C	25 min	2 h	4 h
10° C	15 min	80 min	160 min
20° C	6 min	45 min	90 min
30° C	4 min	25 min	50 min
35° C	2 min	20 min	40 min
40° C	1,5 min	15 min	30 min

DISPENSING TOOLS



Cat No.	Type	Cartridge Size [ml]	Box Quantity	Carton Quantity	List Price per Box
DFC1610000	Manual	300	1	12	£19.05
DFC1610050	Manual	360	1	10	£28.21
DFC1610100	Manual	410	1	10	£30.21
DFC1610150	Heavy Duty Manual	410	1	10	£169.35
DFC1630250	Pneumatic	410	1	-	£483.24
DFC1630000	Pneumatic	825	1	-	£930.95

AC100-NORDIC STYRENE FREE VINYLESTER ANCHOR

DESCRIPTION

- Formulation specifically designed for use in extreme cold down to -20°C
- Stays easy to pump even at low temperatures
- Suitable for water filled drill holes and overhead applications
- Ideal for threaded rods
- Up to 18 month shelf life



Cat No.		Cartridge Size [ml]	Box Quantity	Carton Quantity	List Price per Box
DFC1250000		410	1	10	£14.05

SETTING TIMES

TEMP °C	GEL	SET DRY	SET WET
-20° C	90 min	24 h	48 h
-15° C	75 min	16 h	32 h
-10° C	60 min	10 h	20 h
- 5° C	50 min	5 h	10 h
0° C	25 min	1.50 min	5 h
5° C	10 min	80 min	160 min
+10° C	6 min	60 min	120 min
+15° C	3 min	45 min	90 min
+20° C	1,5 min	35 min	70 min

MATERIALS

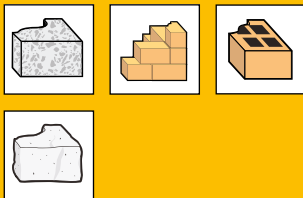

See page 15 for details.

DISPENSING TOOLS



Cat No.	Type	Cartridge Size [ml]	Box Quantity	Carton Quantity	List Price per Box
DFC1610100	Manual	410	1	10	£30.21
DFC1610150	Heavy Duty Manual	410	1	10	£169.35
DFC1630250	Pneumatic	410	1	-	£483.24

PV50-PRO POLYESTER ADHESIVE ANCHOR

DESCRIPTION

- Polyester mortar with an ETA option 7 approval for M8-M24 rods
- Approval valid when using standard trade rods
- Approved for installation down to -5°C
- Up to 18 month shelf life (up to 9 months for 300ml size)

MATERIALS

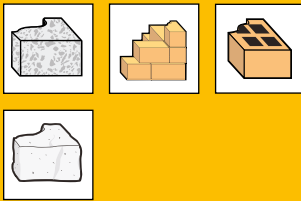

See page 15 for details.

APPROVALS



Cat No.	ETA	Cartridge Size [ml]	Box Quantity	Carton Quantity	List Price per Box
DFC1310000	•	300	1	10	£7.26
DFC1310150	•	360	1	10	£8.21
DFC1310100	•	410	1	10	£7.96

SETTING TIMES

TEMP °C	GEL	SET DRY
-5° C	90 min	360 min
0° C	45 min	180 min
5° C	25 min	120 min
10° C	15 min	80 min
20° C	6 min	45 min
30° C	4 min	25 min
35° C	2 min	20 min

DISPENSING TOOLS



Cat No.	Type	Cartridge Size [ml]	Box Quantity	Carton Quantity	List Price per Box
DFC1610000	Manual	300	1	12	£19.05
DFC1610050	Manual	345 / 360	1	10	£28.21
DFC1610100	Manual	410	1	10	£30.21
DFC1610150	Heavy Duty Manual	410	1	10	£169.35
DFC1630250	Pneumatic	410	1	-	£483.24

PV45-PRO STYRENE-FREE POLYESTER ADHESIVE ANCHOR

DESCRIPTION

- ETA approved for uncracked concrete, solid and hollow brick
- Quick curing
- Styrene free low odour formulation
- Ideal for threaded rods
- Up to 9 month shelf life



Cat No.		 Cartridge Size [ml]	 Box Quantity	 Carton Quantity	List Price per Box
DFC1320000	•	300	1	10	£8.33

MATERIALS

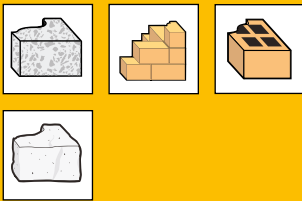

See page 15 for details.

APPROVALS



SETTING TIMES

TEMP °C	GEL	SET DRY
- 5° C	90 min	360 min
0° C	45 min	180 min
5° C	25 min	120 min
10° C	15 min	80 min
20° C	6 min	45 min
30° C	4 min	25 min
35° C	2 min	20 min

DISPENSING TOOLS

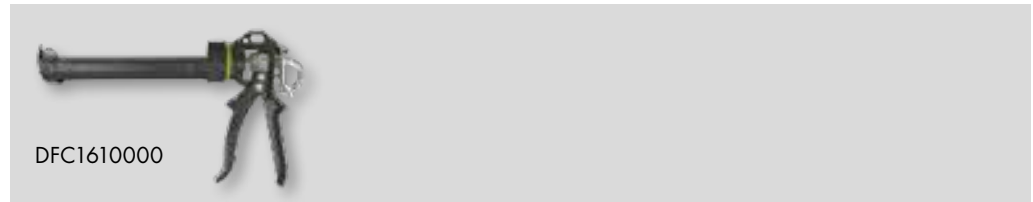





Cat No.	Type	 Cartridge Size [ml]	 Box Quantity	 Carton Quantity	List Price per Box
DFC1610000	Manual	300	1	12	£19.05

SC-PRO VINYLESTER SPINNING CAPSULES

DESCRIPTION

- ETA option 7 approval for uncracked concrete
- Vinylester spinning capsules also suitable for diamond drilled holes
- For use in combination with chisel point threaded rods
- Amount of mortar is exactly fitted to the drill hole diameter and hole depth
- Up to 18 month shelf life



Cat No.		 Drill Dia. [mm]	 Thread Size [mm]	 Box Quantity	 Carton Quantity	List Price per Box
DFC1510000	•	10	M8	10	500	£7.43
DFC1510050	•	12	M10	10	500	£7.44
DFC1510100	•	14	M12	10	500	£7.59
DFC1510150	•	18	M16	10	200	£8.67
DFC1510200	•	22	M20	10	100	£18.17
DFC1510250	•	26	M24	10	100	£22.62
DFC1510300	•	32	M30	5	50	£21.19

SETTING TIMES

TEMP °C	SET DRY	SET WET
> -5° C	5 h	10 h
> +5° C	60 min	120 min
> +20° C	20 min	40 min
> +30° C	10 min	20 min

MATERIALS

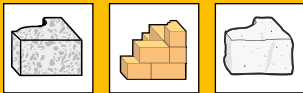

See page 15 for details.

APPROVALS



ACCESSORIES



Professional accessories range for DeWALT adhesive anchors

Includes nozzles, brushes, sleeves and threaded rods, all manufactured to the same high standards to ensure a quality fixing.

For dispensing tools please see pages 48-54.

MIXING NOZZLES

DESCRIPTION

- White 18 element nozzle for use with PURE1 10-PRO, PURE150-PRO & AC100-PRO 825ml
- Black 14 element nozzle for use with AC100-PRO, PV50-PRO & PV45-PRO

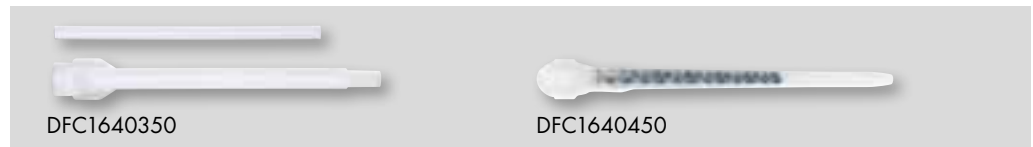

Cat No.	Description	Box Quantity	Carton Quantity	List Price per Box
DFC1640350	White - 18-Element	10	-	£12.38
DFC1640450	Black - 14-Element	10	-	£7.10

EXTENSION NOZZLES

DESCRIPTION

- 200-2000mm extensions for use with mixing nozzles

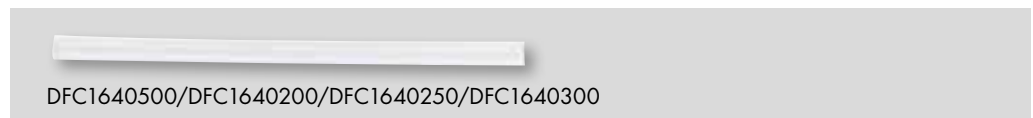

Cat No.	Length [mm]	Box Quantity	Carton Quantity	List Price per Box
DFC1640500	200	10	-	£5.04
DFC1640200	500	10	-	£6.73
DFC1640250	1000	10	-	£10.77
DFC1640300	2000	10	-	£20.20

PISTON PLUGS

DESCRIPTION

- Plugs available for 10-32mm diameter rebar and for threaded rods (see table)

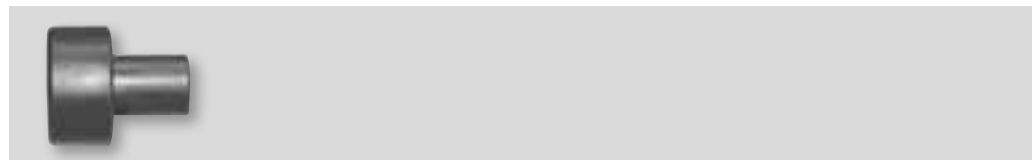

Cat No.	Type	Rebar Size [mm]	Thread Size [mm]	Box Quantity	Carton Quantity	List Price per Box
DFC1690000	#14	Ø10	M12	10	100	£0.47
DFC1690050	#16	Ø12	M14	10	100	£0.48
DFC1690150	#20	Ø16	M18	10	100	£0.58
DFC1690250	#25	Ø20	-	10	100	£0.69
DFC1690300	#28(27/29)	Ø22	M24	10	100	£0.74
DFC1690350	#32	Ø24-25	M27	10	100	£0.86
DFC1690400	#35(34/36)	Ø28-32	M30	10	100	£0.89

BLOW PUMP

DESCRIPTION

- Manual blow pump for improved clearance of debris in drilled holes

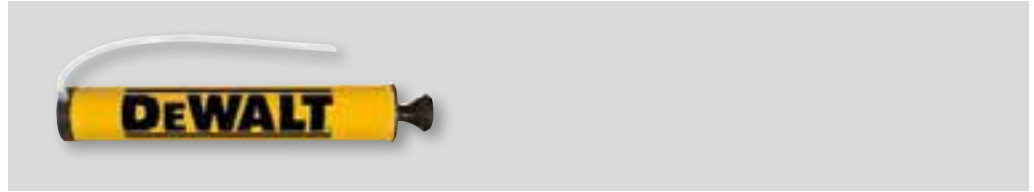

Cat No.	Box Quantity	Carton Quantity	List Price per Box
DFC1650050	1	-	£19.62

STEEL BRUSHES AND SDS EXTENSIONS

DESCRIPTION

- Steel brushes and extensions for installation of ETA approved adhesive anchors

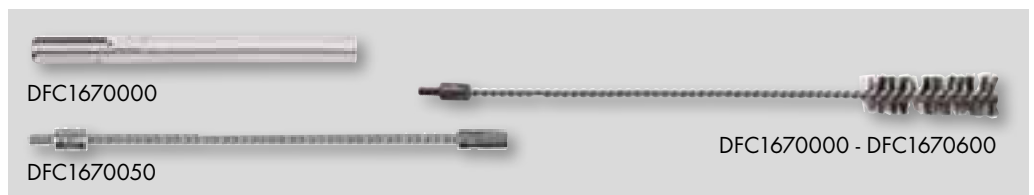

Cat No.	Length [mm]	Drill Dia. [mm]	Rebar Size [mm]	Thread Size [mm]	Box Quantity	Carton Quantity	List Price per Box
DFC1670000	-	-	-	-	1	100	£2.60
DFC1670050	300	-	-	-	1	100	£4.08
DFC1670100	170	10	-	M8	1	100	£4.28
DFC1670150	170	12	Ø8	M10	1	100	£4.28
DFC1670200	200	14	Ø10	M12	1	100	£4.28
DFC1670250	200	16	Ø12	-	1	100	£4.47
DFC1670300	300	18	Ø14	M16	1	100	£4.74
DFC1670350	300	20	Ø16	-	1	100	£4.63
DFC1670400	300	24	Ø20	M20	1	100	£4.63
DFC1670450	300	28	-	M24	1	100	£4.79
DFC1670500	300	32	Ø25	M27	1	100	£4.87
DFC1670550	300	35	Ø28	M30	1	100	£4.98
DFC1670600	300	37	Ø32	-	1	100	£5.18

BRUSHES

DESCRIPTION

- Nylon brush for quick cleaning of drilled holes
- Not recommended for ETA approved applications



Cat No.	Drill Dia. [mm]	Box Quantity	Carton Quantity	List Price per Box
DFC1660000	8-10	1	100	£1.87
DFC1660050	10-14	1	100	£4.28
DFC1660100	16-28	1	100	£4.52





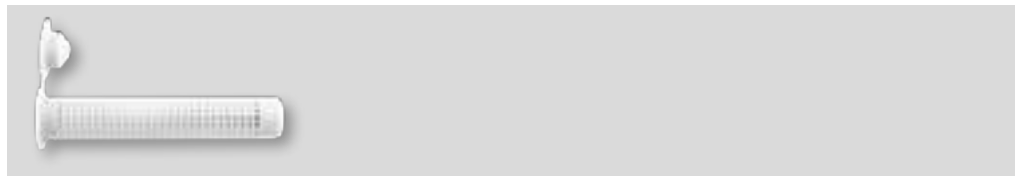

ADHESIVE ANCHOR SLEEVES

DESCRIPTION

- Plastic and mesh sleeves for using adhesive anchors in hollow base materials







PLASTIC SLEEVES



Cat No.	 Length [mm]	 Drill Dia. [mm]	 Diameter [mm]	 Thread Size [mm]	 Box Quantity	 Carton Quantity	List Price per Box
DFC4710000	80	12	12	M6 - M8	10	-	£4.57
DFC4710050	85	16	16	M8 - M10	10	-	£4.63
DFC4710100	85	20	20	M12 - M16	10	-	£5.45







PLASTIC SLEEVES FOR AC100-PRO



Cat No.	 Length [mm]	 Drill Dia. [mm]	 Diameter [mm]	 Thread Size [mm]	 Box Quantity	 Carton Quantity	List Price per Box
DFC4720000	100	14	13	M8	10	-	£5.88
DFC4720050	100	16	15	M10 - M12	10	-	£7.10

MESH SLEEVES



Cat No.	 Length [mm]	 Drill Dia. [mm]	 Diameter [mm]	 Thread Size [mm]	 Box Quantity	 Carton Quantity	List Price per Box
DFC4730000	1000	12	11	M8	1	10	£9.90
DFC4730050	1000	16	15	M10 - M12	1	10	£10.60
DFC4730100	1000	22	20	M16 - M18	1	10	£13.43

CHISEL POINT THREADED RODS

DESCRIPTION

- Chisel point rods available with zinc plated or A4 stainless steel finish
- Suitable for SC-PRO Spinning capsules

ZINC PLATED CLASS 5.8 STEEL

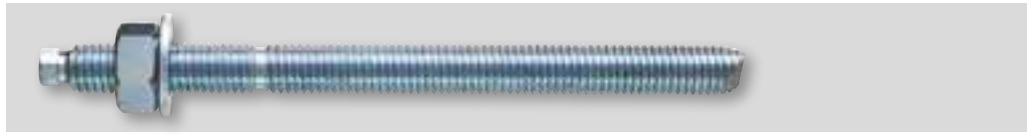

Cat No.	Length [mm]	Drill Dia. [mm]	Thread Size [mm]	Box Quantity	Carton Quantity	List Price per Box
DFC4130000	110	10	M8	10	200	£2.43
DFC4130050	130	12	M10	10	200	£3.81
DFC4130100	160	14	M12	10	100	£5.48
DFC4130150	190	18	M16	10	80	£10.71
DFC4130200	260	24	M20	5	25	£16.07
DFC4130250	300	28	M24	5	20	£29.40

A4 STAINLESS STEEL

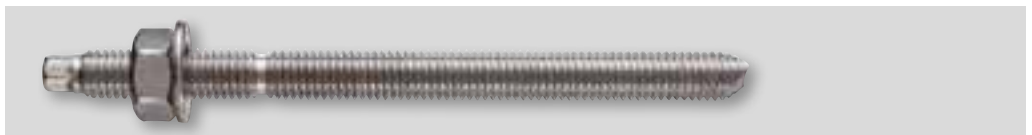

Cat No.	Length [mm]	Drill Dia. [mm]	Thread Size [mm]	Box Quantity	Carton Quantity	List Price per Box
DFC4150000	110	10	M8	10	200	£11.47
DFC4150050	130	12	M10	10	200	£25.00
DFC4150100	160	14	M12	10	100	£32.48
DFC4150150	190	18	M16	10	80	£98.81
DFC4150200	260	24	M20	5	25	£88.10
DFC4150250	300	28	M24	5	20	£120.12

STRAIGHT CUT THREADED RODS

DESCRIPTION

- Straight cut threaded rods
- Hot dip galvanized for extra corrosion resistance

HOT DIPPED GALVANIZED

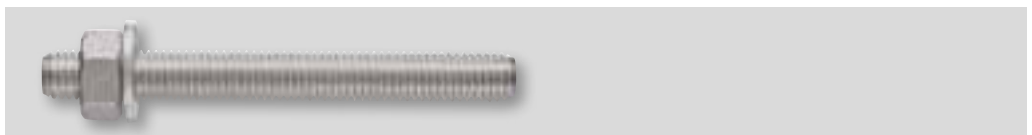

Cat No.	Length [mm]	Drill Dia. [mm]	Thread Size [mm]	Box Quantity	Carton Quantity	List Price per Box
DFC4170000	110	10	M8	25	200	£12.49
DFC4170040	130	12	M10	25	100	£19.27
DFC4170160	160	14	M12	10	100	£11.58
DFC4170200	190	18	M16	10	40	£19.87
DFC4170320	260	24	M20	10	20	£49.71
DFC4170400	290	28	M24	10	20	£66.39

**LIGHT DUTY
ANCHORS**



FASTENERS AND FIXINGS FOR EVERY TASK

The **DEWALT** range of light duty fasteners provides quick fixing solutions for a wide variety of substrates.

Designed and manufactured to the same exacting standards as our heavy duty and adhesive anchors range, all the products in the **DEWALT** light duty range are tested for suitability with pull out testing where appropriate.

The range includes drywall and wall anchors which are designed to self-drill into the material with minimal damage to the substrate and spread the load to prevent pull out. Hammer-in anchors are also available for quick fastening.

Anchors for general fixing applications are also available including screw anchors, plugs and plastic wall anchors.

PRODUCT		Quantity	BASE MATERIAL												
			Un-cracked concrete	Hollow-core concrete slabs	Natural stone	Solid brick/masonry	Hollow brick	Sand-limestone solid	Perforated sand-lime stone	Lightweight concrete	Aerated concrete	Gypsum board	Gypsum block	Chipboard	Wood
	ZIP-IT® PLASTERBOARD ANCHOR	62										✓	✓		
	ZIP-TOGGLE® WITH SCREW	62										✓			
	LEGS® WALL ANCHOR	63										✓	✓		
	ST STRAP TOGGLE™	63		✓								✓		✓	
	WALL-DOG™ SCREW ANCHOR	64	✓	✓	✓	✓	✓	✓	✓	✓	✓	✓	✓	✓	✓
	HWA HOLLOW WALL ANCHOR	65										✓		✓	
	NP NYLON PLUG	66	✓	✓	✓	✓			✓		✓		✓		
	SHARKIE™ PLASTIC WALL ANCHOR	67	✓	✓	✓	✓	✓	✓	✓	✓	✓	✓	✓	✓	✓
	AERATED CONCRETE ANCHOR	68										✓		✓	
	PX UNIVERSAL PLUG	69	✓	✓	✓	✓	✓	✓	✓	✓	✓	✓	✓	✓	

ZIP-IT® PLASTERBOARD ANCHORS

DESCRIPTION

- One piece self drilling anchor designed for use in plasterboard for light duty loads
- Includes screws

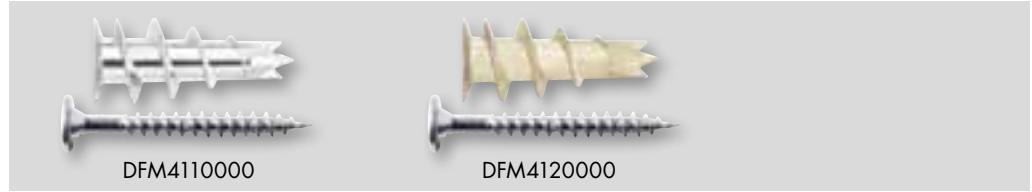



APPLICATIONS

- Light duty applications including:
- Brackets
 - Mirrors
 - Signage
 - Light bathroom fittings

MATERIALS



See page 15 for details.

Cat No.	 Box Quantity	 Carton Quantity	List Price per Box
DFM4110000	100	800	£8.93
DFM4120000	100	800	£7.50

ZIP-TOGGLE® WITH SCREWS

DESCRIPTION

- Self drilling hollow gypsum wallboard anchor
- Unique patented design
- Includes screws

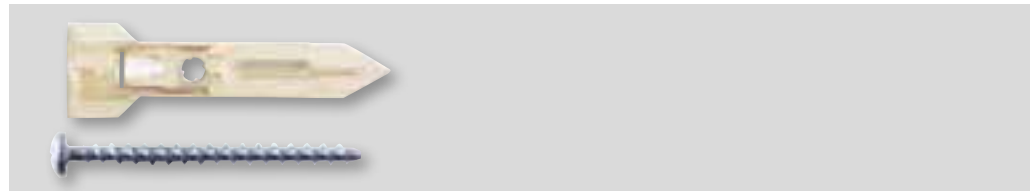



APPLICATIONS

- Light duty applications including:
- Brackets
 - Mirrors
 - Signage
 - Light bathroom fittings

MATERIALS



See page 15 for details.

Cat No.	 Length [mm]	 Box Quantity	 Carton Quantity	List Price per Box
DFM4570000	50	50	400	£7.26

LEGS® WALL ANCHORS

DESCRIPTION

- Fast and easy to use expansion anchor designed for use in wallboard
- The anchor has a pierce point, requiring no pre-drilling
- Includes screws



APPLICATIONS

- Light duty applications including:
- Curtain hooks
 - Pictures and mirrors

MATERIALS



See page 15 for details.

Cat No.	Length [mm]	Box Quantity	Carton Quantity	List Price per Box
DFM4470000	35	100	800	£18.06

ST STRAP TOGGLES™

DESCRIPTION

- Easy to install toggle fixing
- Patented hollow wall anchor for higher loads
- Reusable in the same hole (remove the bolt without losing the anchor)



APPLICATIONS

- Light duty applications including:
- Pictures and mirrors
 - Light sanitary fixings
 - Metal brackets

MATERIALS



See page 15 for details.

Cat No.	Drill Dia. [mm]	Thickness member [mm]	Thread Size [mm]	Box Quantity	Carton Quantity	List Price per Box
DFM4540050	12	80	M6	50	100	£14.70
DFM4540100	18	65	M8	25	50	£9.89

WALL-DOG™ SCREW ANCHORS

DESCRIPTION

- An all steel, tension-free, one piece, threaded fastener
- Use to fasten various fixtures directly to drywall, wood, concrete, sand-lime stone or brickwork
- No plug needed
- No pre-drilling required in wood, drywall and gypsum board

APPLICATIONS

Light to medium duty applications including:

- Curtain tracks
- Electrical sockets and switches



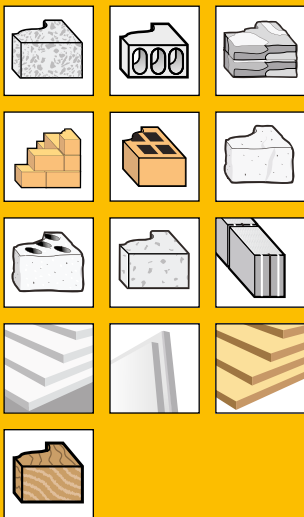

MATERIALS

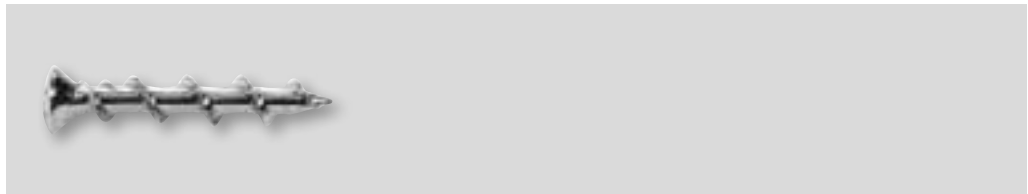

See page 15 for details.





COUNTERSUNK

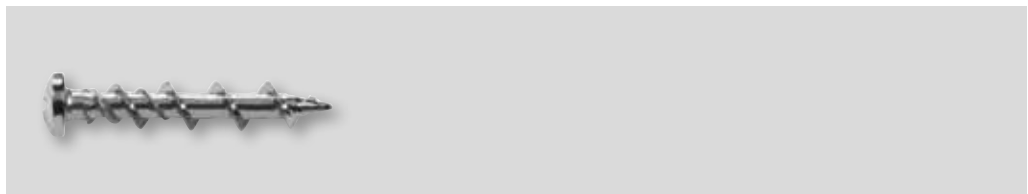

Cat No.	Head Colour	 Length [mm]	 Head Size [mm]	 Max t_{fix} [mm]	 Box Quantity	 Carton Quantity	List Price per Box
DFM424000P	White	32	8	3	100	2000	£7.99
DFM424015P	Chrome	32	8	3	100	2000	£8.54

PAN HEAD



Cat No.	Head Colour	 Length [mm]	 Head Size [mm]	 Max t_{fix} [mm]	 Box Quantity	 Carton Quantity	List Price per Box
DFM425000P	White	32	8	3	100	2000	£7.99
DFM425005P	Chrome	32	8	3	100	2000	£8.54

HWA HOLLOW WALL ANCHORS

DESCRIPTION

- Sleeve type hollow wall anchor designed for use in base materials such as plaster, wallboard, concrete block, hollow tile or plywood
- Once the anchor has been set, the screw may be removed as often as necessary without influencing load values

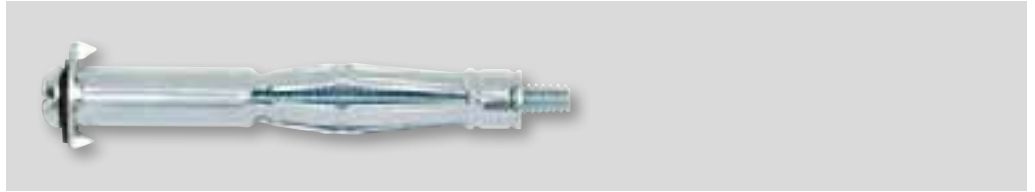

Cat No.	Thread Size [mm]	Length [mm]	Drill Dia. [mm]	Max t_{fix} [mm]	Box Quantity	Carton Quantity	List Price per Box
DFM4410050	4 x 45		8	20	100	800	£12.00
DFM4410150	5 x 45		10	24	100	800	£15.48
DFM4410200	5 x 60		10	26	50	400	£9.52
DFM4410300	6 x 60		12	26	50	400	£10.71

APPLICATIONS

Light to medium duty applications including:

- Shelving brackets
- Kitchen and bathroom fittings
- Lighting

MATERIALS



See page 15 for details.

HWA HOLLOW WALL ANCHOR SETTING TOOL

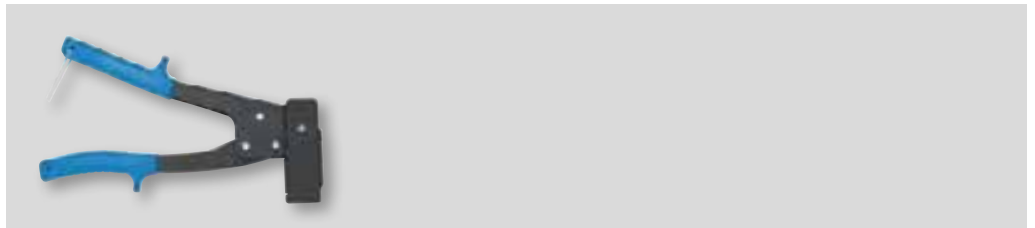

Cat No.	Box Quantity	Carton Quantity	List Price per Box
DFM4400000	1	25	£11.23

NP NYLON PLUGS

DESCRIPTION

- Nylon expansion fixing
- Anti rotation barbs resists spinning in the hole
- Heavily ribbed design improves pull out strength
- Suitable for wood and chipboard screws

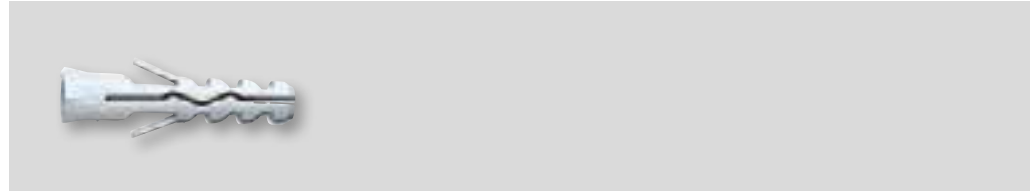

APPLICATIONS

General light duty fittings including:

- Pictures
- Skirting
- Curtain rails
- Motion sensors

MATERIALS

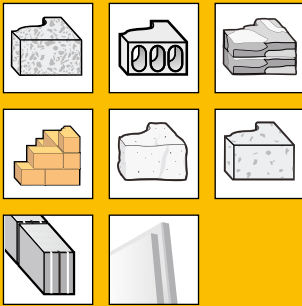

See page 15 for details.





Cat No.	Length [mm]	Drill Dia. [mm]	Box Quantity	Carton Quantity	List Price per Box
DFM3440000	25	5	100	1600	£0.97
DFM3440050	30	6	100	1600	£1.08
DFM3440150	40	8	100	800	£1.52
DFM3440200	50	10	50	400	£1.12
DFM3440250	60	12	25	400	£0.94
DFM3440300	80	14	20	400	£3.41

SHARKIE™ PLASTIC WALL ANCHORS

DESCRIPTION

- All purpose wall anchor
- The anchor moulds and conforms exactly to the surface of the hole
- Won't spin or countersink into the hole
- Provides an inexpensive rust proof installation when used with stainless steel screws



Cat No.	 Length [mm]	 Drill Dia. [mm]	 Box Quantity	 Carton Quantity	List Price per Box
DFM4460050	30	6	100	1600	£2.83
DFM4460100	40	8	100	800	£4.70

APPLICATIONS

General light duty fittings including:

- Shelving
- Bathroom accessories
- Flat screen TV brackets
- Draperies
- Curtain rods and blinds

MATERIALS

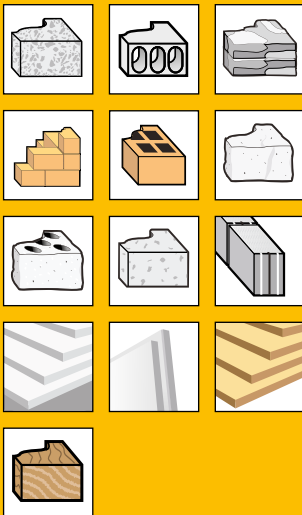





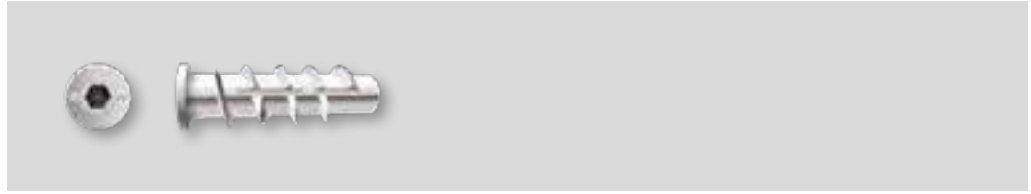

See page 15 for details.

AERATED CONCRETE ANCHORS

DESCRIPTION

- Removeable tension-free fastening for aerated concrete block
- Spiral thread cuts a positive fit into the block with no spalling of the plastered surface
- The interrupted thread ensures removal of waste material for easier installation
- High grade nylon for improved temperature
- Simple and quick to install with allen keys
- Flexible screw choice - suitable for both wood and metric screws



Cat No.	 Shank Dia. [mm]	 Drill Dia. [mm]	 Length [mm]	 Allen Key	 Box Quantity	 Carton Quantity	List Price per Box
DFM3450100	M6 x 10		50	SW6	50	400	£6.93
DFM3450200	M8 x 12		60	SW8	50	200	£8.90
DFM3450300	M10 x 14		70	SW10	40	160	£8.93

APPLICATIONS

- Pictures
- Shelves
- Letter boxes
- Motion sensors
- Lighting
- Mirror cabinets
- Signs
- Cable and pipe clamps

MATERIALS



See page 15 for details.

PX UNIVERSAL PLUGS

DESCRIPTION

- Nylon universal fixing
- Expansion in solid building materials, reliable knot formation in all hollow building materials
- Suitable for wood and chipboard screws

APPLICATIONS

General light duty fittings including:





- Pictures
- Skirting
- Curtain rails
- Motion sensors

MATERIALS

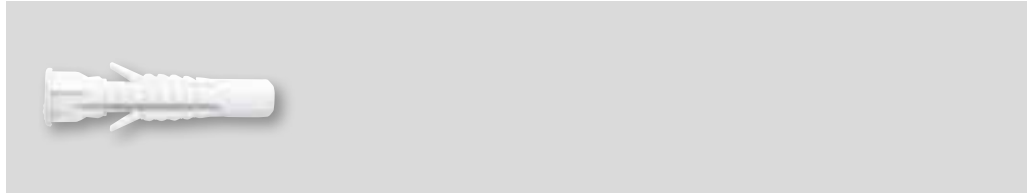

See page 15 for details.



Cat No.	 Length [mm]	 Drill Dia. [mm]	 Box Quantity	 Carton Quantity	List Price per Box
DFM3460000	35	6	100	1200	£2.56
DFM3460050	50	8	100	1200	£4.83
DFM3460100	60	10	50	600	£4.87

**DIRECT
FASTENING**



POWER WITH CONTROL.

The **DEWALT** gas and powder actuated fastening systems include nailers, accessories and fasteners that can drive into the hardest of materials.

Whether you choose gas or powder actuated, the tools offer flexibility and ease of use so you can get the job done quickly and professionally, and are ideal for timber to concrete, heavy duty steel to steel or steel to concrete applications.

DEWALT C5 TRAK-IT TOOL

Lighter, faster and more reliable than other tools on the market, the gas powered C5 Trak-It® nailer can drive up to 900 nails per fuel cell and has been specifically designed for fast installation of drywall track as well as general construction applications.

The Stick-E range also gives you the ability to drive clips and fasteners designed specifically for conduit and insulation installation.

POWDER ACTUATED TOOLS

DEWALT powder actuated tools give you high power fixing with high quality, hardened steel fasteners making them ideal for driving clips and fittings into concrete and steel.

The P3X can be changed easily from a single shot to magazine-fed tool making it ideally suited to drywall track installation.

DEWALT Powder loads are colour coded according to their ability to penetrate base materials.



						BASE MATERIAL										
						Uncracked concrete	Hollow-core concrete slabs	Solid brick/masonry	Sand-lime stone solid	Lightweight concrete	Metal profile	Wood	Steel			
GAS POWERED	C5 TRAK-IT® STICK-E CLIPS & WASHERS	73		Drywall	Electricians/Plumbers	General Construction	✓	✓	✓	✓	✓	✓	✓	✓	✓	✓
	C5 TRAK-IT® NAILS	74	✓	✓	✓	✓	✓	✓	✓	✓	✓	✓	✓	✓	✓	✓
	C5 TRAK-IT® XH NAILS	74	✓	✓	✓	✓	✓	✓	✓	✓	✓	✓	✓	✓	✓	✓
	C3 TRAK-IT® NAILS	75	✓	✓	✓	✓	✓	✓	✓	✓	✓	✓	✓	✓	✓	✓
	C3 TRAK-IT® XH	75	✓	✓	✓	✓	✓	✓	✓	✓	✓	✓	✓	✓	✓	✓
POWDER ACTUATED	P3X PINS	76	✓	✓	✓	✓	✓	✓	✓	✓	✓	✓	✓	✓	✓	✓
	DRIVE PINS - STANDARD	78	✓	✓	✓	✓	✓	✓	✓	✓	✓	✓	✓	✓	✓	✓
	DRIVE PINS - WASHERED HEAD	78	✓	✓	✓	✓	✓	✓	✓	✓	✓	✓	✓	✓	✓	✓
	DRIVE PINS - INSULATED WASHER	78	✓	✓	✓	✓	✓	✓	✓	✓	✓	✓	✓	✓	✓	✓
	DRIVE PINS - CONDUIT CLIPS	79	✓	✓	✓	✓	✓	✓	✓	✓	✓	✓	✓	✓	✓	✓
COLLATED DRYWALL SCREWS		81	✓	✓	✓	✓	✓	✓	✓	✓	✓	✓	✓	✓	✓	✓

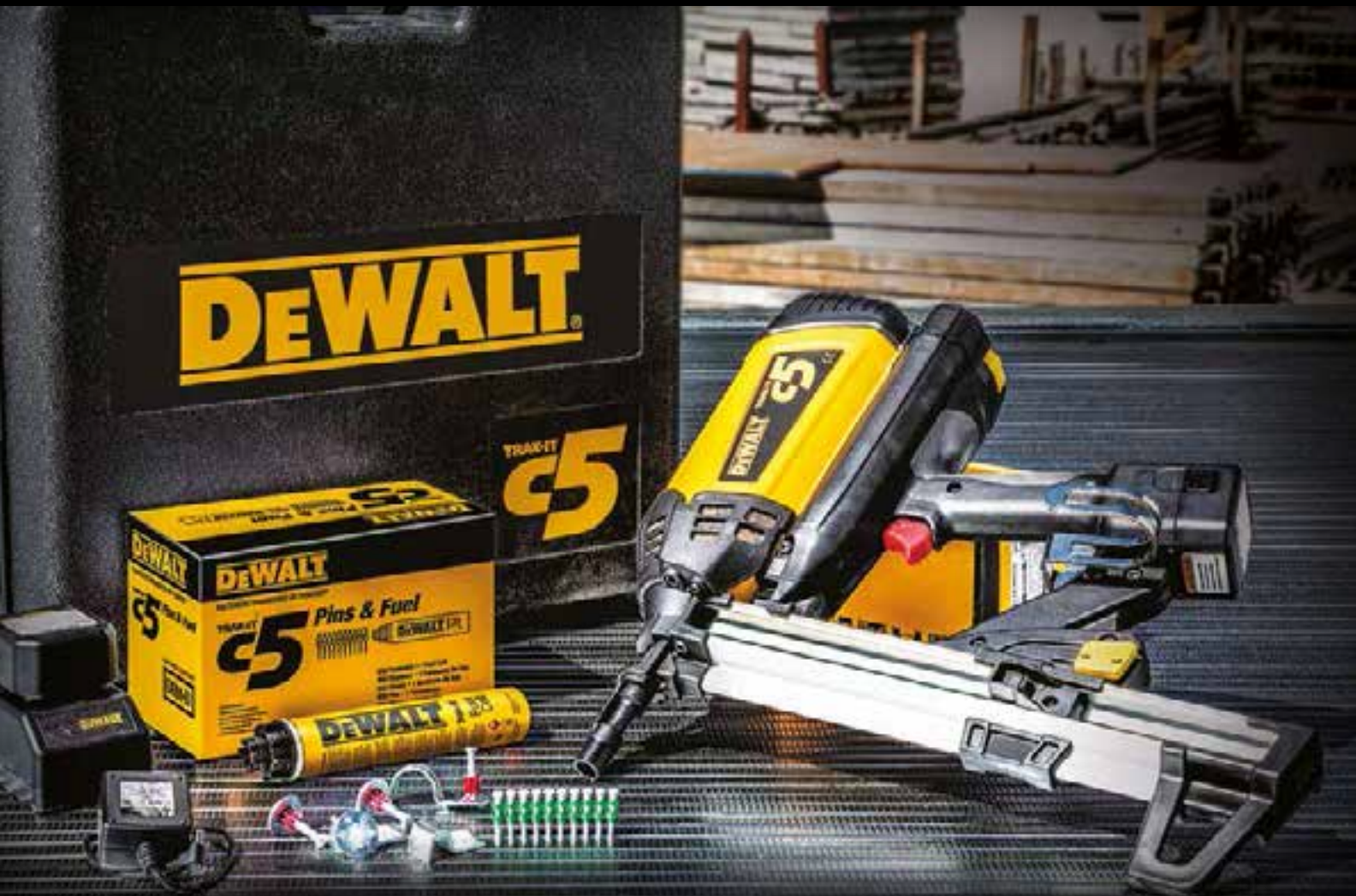

C5 TRAK-IT GAS TOOL & ACCESSORIES

LIGHTWEIGHT, POWERFUL & COMPACT GAS NAILER.

The C5 Trak-It is a powerful gas nailer designed for driving nails into a wide range of substrates including steel, concrete, brick and hollow brick.

It is ideal for metal track installation as well as second fix nailing including conduit clips and fittings.

DEWALT tools are designed to stand up to the demands of on-site use and the C5 is no exception with a host of features that ensure reliable operation and user comfort:

- The lightest and smallest tool in its class
- Less operator fatigue with a better overall ergonomic feel and extreme manoeuvrability
- Power output of 105 Joules for shooting into even the hardest concrete
- Smart fan – ventilator time computer adjusted to tool and environmental temperature
- Metal mesh suction filter provides highly effective dust protection

The Trak-It system is also ETA approved for XH nails from 22-27mm in concrete applications. The XH nails have a special zinc plating making them able to drive into very hard concrete with a 'step-shank' design for optimal penetration.

C5 TRAK-IT KIT, BATTERIES & CHARGER

APPLICATIONS

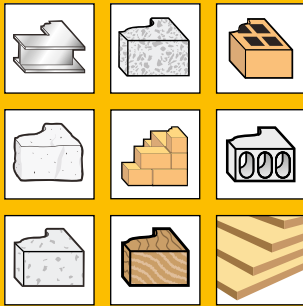

- Drywall steel track installation on to concrete, block or steel
- Plywood to concrete or block
- Furring strips to concrete or block
- General construction applications

MATERIALS





See page 15 for details.



Cat No.	Description	 Box Quantity	 Carton Quantity	List Price per Box
DDF5110500	C5 Trak-It Kit - Long Track	1	-	£877.42
DDF5120550	C5 Trak-It Kit - Short Track	1	-	£877.42
DDF5140500	C5 Trak-It Gas Canister - Qty 1	20	80	£160.03
DDF5150500	C5 Replacement Magazine - Long Track	1	30	£95.03
DDF5150550	C5 Replacement Magazine - Short Track	1	30	£95.03

C5 TRAK-IT BATTERY & CHARGER



Cat No.	Description	 Box Quantity	 Carton Quantity	List Price per Box
DDF5610500	C5 Trak-It Battery	1	-	£40.58
DDF5610510	C5 Trak-It 220V Adapter Cord	1	-	£27.98
DDF5610520	C5 Trak-It Charger Base	1	-	£43.10

C5 TRAK-IT STICK-E CLIPS & WASHERS



DESCRIPTION

- Easy to install with the DEWALT C5 Trak-It gas actuated nailer
- Attaches easily to the Trak-It nose piece

APPLICATIONS

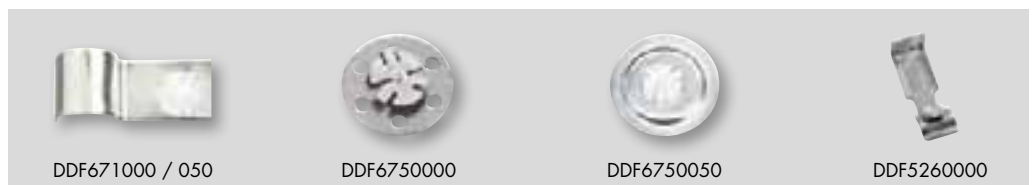
- Cabling conduit
- Insulation
- Lathing



Cat No.	Description	 Diameter [mm]	 Box Quantity	 Carton Quantity	List Price per Box
DDF6710000	Stick-E Conduit Clip - 16mm	16	250	500	£35.71
DDF6710050	Stick-E Conduit Clip - 20mm	20	250	500	£38.69
DDF6750000	Stick-E 25mm Lathing Washer	25	200	3200	£19.05
DDF6750050	Stick-E 36mm Insulated Washer	36	100	1000	£10.71
DDF5260000	Stick-E Rod Hanger - 6mm	6	100	200	£39.39

C5 TRAK-IT NAILS

DESCRIPTION

- Zinc plated ballistic nails from 15-40mm

APPLICATIONS

General medium duty construction applications including:

- Drywall steel track installation into concrete, block or steel
- Plywood to concrete or block
- Furring strips to concrete or block



Cat No.	Length [mm]	Shank Dia. [mm]	Head Size [mm]	Box Quantity	Carton Quantity	List Price per Box
DDF6110000	15	2.6	6.3	800+1	4000+5	£68.04
DDF6110050	20	2.6	6.3	800+1	4000+5	£51.36
DDF6110100	25	2.6	6.3	800+1	4000+5	£50.82
DDF6110150	30	2.6	6.3	800+1	4000+5	£57.12
DDF6110200	35	2.6	6.3	800+1	4000+5	£57.96
DDF6110250	40	2.6	6.3	800+1	4000+5	£67.63

C5 TRAK-IT XH NAILS FOR VERY HARD CONCRETE

DESCRIPTION

- Special zinc plated nails for very hard concrete
- High performance design for optimal penetration
- Stepshank design for optimal penetration
- 22-27mm ETA approved for fastening on concrete (only valid with Trak-It C5)



Cat No.	Length [mm]	Shank Dia. [mm]	Head Size [mm]	Box Quantity	Carton Quantity	List Price per Box
DDF6310000	17	3	6.3	800+1	4000+5	£78.12
DDF6310100	• 22	3	6.3	800+1	4000+5	£82.74
DDF6310150	• 27	3	6.3	800+1	4000+5	£87.78

APPLICATIONS

General heavy duty construction applications including:

- Drywall steel track installation on to concrete, block or steel
- Plywood to concrete or block
- Furring strips to concrete or block
- Prefabricated materials

APPROVALS





C3 TRAK-IT ACCESSORIES

DESCRIPTION

- Accessories range for use with C3 Trak-It nailer



Cat No.	Description	 Box Quantity	 Carton Quantity	List Price per Box
DDF5330000	C3 Blue Trak-It Gas Can	20	80	£144.35
DDF5610500	C3 Trak-It Battery	1	-	£40.58
DDF5610510	C3 Trak-It 220V Adapter Cord	1	-	£27.98
DDF5610520	C3 Trak-It Charger Base	1	-	£43.10

C3 TRAK-IT NAILS

DESCRIPTION





- Zinc plated ballistic nails from 13-38mm

APPLICATIONS

General medium duty construction applications including:

- Drywall steel track installation into concrete, block or steel
- Plywood to concrete or block
- Furring strips to concrete or block



Cat No.	 Length [mm]	 Shank Dia. [mm]	 Head Size [mm]	 Box Quantity	 Carton Quantity	List Price per Box
DDF6120000	13	2.6	6.3	1000+1	5000+5	£78.05
DDF6120200	32	2.6	6.3	1000+1	5000+5	£79.48
DDF6120250	38	2.6	6.3	1000+1	5000+5	£78.52

C3 TRAK-IT XH NAILS FOR VERY HARD CONCRETE

DESCRIPTION





- Special zinc plated nails for very hard concrete

APPLICATIONS

General heavy duty construction applications:

- Drywall steel track installation on to concrete, block or steel
- Plywood to concrete or block
- Furring strips to concrete or block
- Prefabricated materials



Cat No.	 Length [mm]	 Shank Dia. [mm]	 Head Size [mm]	 Box Quantity	 Carton Quantity	List Price per Box
DDF6320020	17	3.0	6.3	1000+1	5000+5	£75.19
DDF6320100	22*	3.0	6.3	1000+1	5000+5	£91.86
DDF6320170	27	3.0	6.3	1000+1	5000+5	£91.86

APPROVALS



P3X POWDER ACTUATED TOOL & POWDER LOADS

DESCRIPTION

- Powder actuated nailer
- Fires pins from 15-60mm (with magazine) or 15-76mm (single shot)
- Power adjuster for precise penetration into all base materials
- Can be quickly changed from single shot to magazine-fed
- Adjustable magazine
- Easy maintenance
- P3X pins and return spring also suitable for use with other brands of tools

APPLICATIONS

- Drywall steel track installation on to concrete, block or steel
- Wood to concrete and steel
- Electrical fittings to concrete
- Concrete forming
- Double partitions to concrete
- Brick ties
- Composite decking
- Insulation panels
- Waterproofing
- Steel grids

MATERIALS

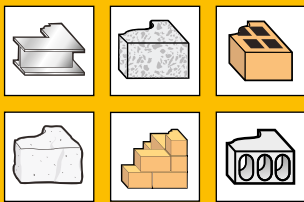

See page 15 for details.



Cat No.	Description	Box Quantity	Carton Quantity	List Price per Box
DDF2130000	P3X PAT .25 Cal 10mm Disc Tool	1	-	£701.47
DDF2230000	P3X Rubber Return Spring	1	25	£5.89

P3X PINS

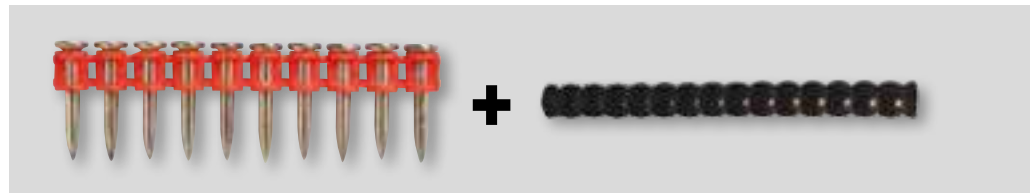

Cat No	Length [mm]	Shank Dia. [mm]	Head Size. [mm]	Box Quantity	Carton Quantity	List Price per Box
DDF3440000	15	3.7	8.6	500+1	2500+5	£33.39
DDF3440050	20	3.7	8.6	500+1	2500+5	£33.39
DDF3440100	25	3.7	8.6	500+1	2500+5	£35.07
DDF3440150	30	3.7	8.6	500+1	2500+5	£38.64
DDF3440200	35	3.7	8.6	500+1	2500+5	£41.37
DDF3440250	40	3.7	8.6	300+1	1500+5	£27.09
DDF3440300	50	3.7	8.6	300+1	1500+5	£30.37
DDF3440350	60	3.7	8.6	300+1	1500+5	£33.52

.25 CALIBER POWDER LOADS ON DISC

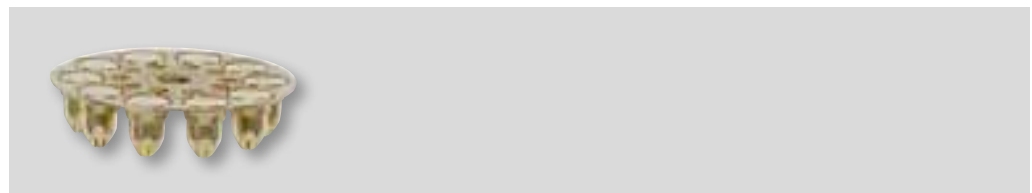

Cat No.	Type	Box Quantity	Carton Quantity	List Price per Box
DDF1220100	■ .25 Caliber Yellow	1000	10000	£7.35
DDF1220200	■ .25 Caliber Red	1000	10000	£7.35

PA3500 POWDER ACTUATED TOOL & POWDER LOADS

DESCRIPTION



- Powder actuated single shot nailer
- Fires pins and clips from 16-76mm
- Powder loads available in 3 types depending on required power
- Includes depth adjuster for fast changes to fastener penetration

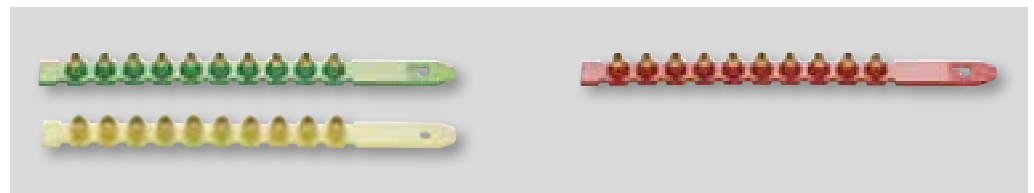

Cat No.	Description	Box Quantity	Carton Quantity	List Price per Box
DDF2120400	PA3500 .27 Caliber Strip Tool	1	-	£298.40

.27 CALIBER POWDER LOADS IN STRIP



Cat No.	Type	Box Quantity	Carton Quantity	List Price per Box
DDF1350000	 .27 Caliber Green	1000	10000	£8.33
DDF1350050	 .27 Caliber Yellow	1000	10000	£8.33
DDF1350100	 .27 Caliber Red	1000	10000	£8.33

APPLICATIONS

- Conduit clips to concrete
- Wood to concrete and steel
- Electrical fittings to concrete
- Concrete forming

MATERIALS

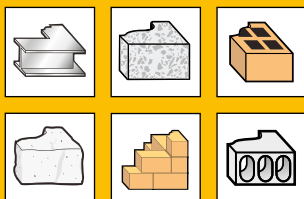

See page 15 for details.





PA3500 / P3X PINS & CLIPS

DESCRIPTION

- Ballistic nails suitable for medium duty applications
- Zinc plated
- Also suitable for other brands of tools including:
Spit® P370
Hilti® DX460





STANDARD DRIVE PINS

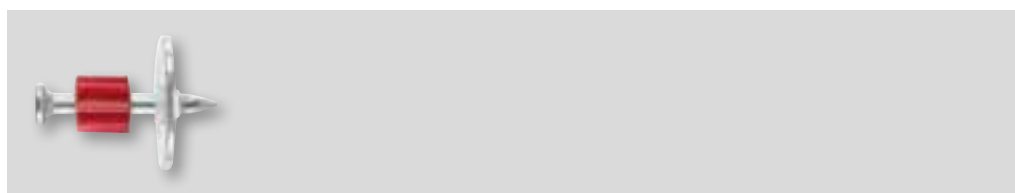

Cat No	 Length [mm]	 Shank Dia. [mm]	 Head Size. [mm]	 Box Quantity	 Carton Quantity	List Price per Box
DDF3010000	16	3.7	7.6	100	5000	£3.49
DDF3000050	19	3.7	7.6	100	5000	£4.04
DDF3000100	25	3.7	7.6	100	5000	£3.32
DDF3000150	27	3.7	7.6	100	1000	£4.20
DDF3000200	32	3.7	7.6	100	1000	£6.00
DDF3000250	38	3.7	7.6	100	1000	£3.86
DDF3000300	44	3.7	7.6	100	1000	£4.31
DDF3000350	51	3.7	7.6	100	1000	£5.06
DDF3000400	57	3.7	7.6	100	1000	£6.14
DDF3000450	64	3.7	7.6	100	1000	£6.72
DDF3000500	70	3.7	7.6	100	1000	£7.19
DDF3000550	76	3.7	7.6	100	1000	£7.48





DRIVE PINS WITH WASHERED HEAD

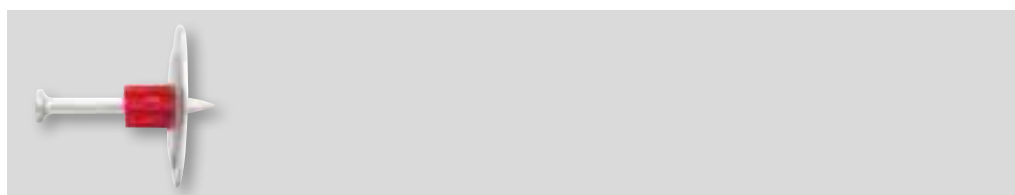

Cat No	 Length [mm]	 Shank Dia. [mm]	 Head Size. [mm]	 Box Quantity	 Carton Quantity	List Price per Box
DDF3060000	25	3.7	7.6	100	1000	£7.64
DDF3060050	37	3.7	7.6	100	1000	£8.19

DRIVE PINS WITH INSULATION WASHER



Cat No	 Length [mm]	 Shank Dia. [mm]	 Head Size. [mm]	 Box Quantity	 Carton Quantity	List Price per Box
DDF3080000	38	3.7	7.6	100	1000	£9.51
DDF3080050	51	3.7	7.6	100	1000	£10.81





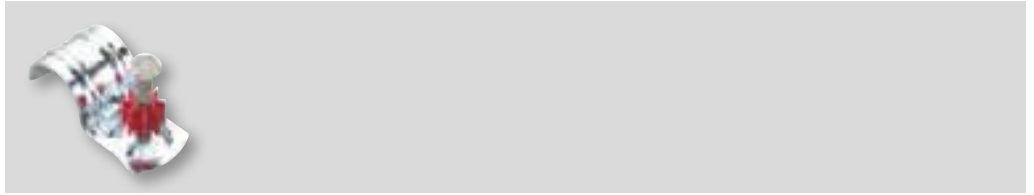

PA3500 / P3X PINS & CLIPS

DESCRIPTION

- Ballistic nail suitable for medium duty applications
- Zinc plated
- Also suitable for other brands of tools including:
Spit® P370
Hilti® DX460

DRIVE PIN WITH CONDUIT CLIP



Cat No	 Length [mm]	 Shank Dia. [mm]	 Head Size. [mm]	 Clip Dia. [mm]	 Box Quantity	 Carton Quantity	List Price per Box
DDF4020100	25	3.7	7.6	13	100	1000	£17.89





POWDER ACTUATED STRIP NAILS

DESCRIPTION

- Suitable for Hilti® DX460/ DXA40/DXA41 and other brands of tools
- Available in lengths from 16mm up to 72mm

PAT STRIP NAILS



Cat No	 Length [mm]	 Shank Dia. [mm]	 Head Size. [mm]	 Box Quantity	 Carton Quantity	List Price per Box
DDF3430000	16	3.7	8	100	1000	£4.83
DDF3410050	19	3.7	8	100	1000	£5.04
DDF3410100	22	3.7	8	100	1000	£4.79
DDF3410150	27	3.7	8	100	1000	£5.12
DDF3410200	32	3.7	8	100	1000	£5.12
DDF3410250	37	3.7	8	100	1000	£5.54
DDF3410300	42	3.7	8	100	1000	£6.30
DDF3410350	47	3.7	8	100	1000	£6.01
DDF3410400	52	3.7	8	100	1000	£6.68
DDF3410450	62	3.7	8	100	1000	£8.17
DDF3410500	72	3.7	8	100	1000	£8.62

COLLATED DRYWALL SCREWS

DESCRIPTION

- Drywall screws with bugle head
- Constant and sharp needle point for fast and easy installation
- Available in fine and coarse thread
- Fine thread for fastening drywall panels to metal profiles (max. 0,88mm)
- Coarse thread for fastening to wooden profiles
- Black phosphate, for better corrosion resistance
- Marking on the head for easy identification
- Specially designed strip for easy installation and to prevent screw jams
- Suitable for DEWALT®, Powers®, HILTI®, Makita®, Senco® and most other competitor screwdrivers

APPLICATIONS

- Fastening drywall panels to metal and wooden profiles

MATERIALS



See page 15 for details.

APPROVALS



DEWALT®
Richard-Klinger-Str. 11
D-65510 Idstein, Germany

EN 14566
Drywall Screw
Fire Resistance: Class A1
Bending Test: Pass

FINE THREAD - FOR METAL PROFILES (MAX. 0,88mm)

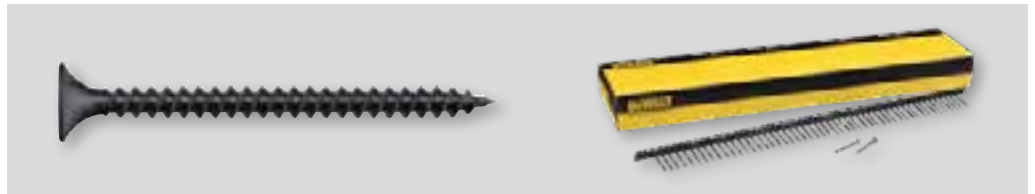

Cat No.	Thread Size [mm]	Length [mm]	Screws per Strip	Box Quantity	Carton Quantity	List Price per Box
DWF4000250	3.5 x 25		50	1000*	10000	-
DWF4000350	3.5 x 35		50	1000*	10000	-
DWF4000450	3.5 x 45		50	1000*	10000	-
DWF4000550	3.5 x 55		50	1000*	8000	-

*Only sold by carton

COARSE THREAD - FOR WOODEN PROFILES



Cat No.	Thread Size [mm]	Length [mm]	Screws per Strip	Box Quantity	Carton Quantity	List Price per Box
DWF4100350	3.5 x 35		50	1000*	10000	-
DWF4100450	3.5 x 45		50	1000*	10000	-
DWF4100550	3.5 x 55		50	1000*	8000	-

*Only sold by carton

www.DEWALT.com

